

42
October
1986

elektor INDIA

Rs. 7.50

electronics



Satellite TV reception

BBC computer

Headphone amp

Research and the future



SATELLITE TV RECEPTION

Much has been said and written about satellite TV over the past few years. But what does this entail? Can anyone receive such programmes? What is the cost of a suitable installation? How does the law stand in regard to reception of these signals and the installation of the necessary equipment? In this introductory article we will attempt to give answers to these questions and others, as well as give a theoretical appreciation and practical information on the subject.

electronics technology

Satellite TV reception	10.20
Electronic propulsion for satellite	10.30
Research and the future	10.38
Software for the BBC computer	10.42
Computers of tomorrow	10.51

projects

Loudspeaker impedance meter	10.34
Headphone amplifier	10.40
723 as a constant current source	10.44
Real load resistors	10.45
Portable mixer -3	10.46

information

News and views	10.17
Corrections	10.74

guide lines

New products	10.60
Switchboard	10.67
Classified ads	10.74
Index of advertisers	10.74

selex - 16

Measuring techniques	10.52
The heavy weight of electronics	10.54
Unknown transformer data	10.56
Transformer coils in series & parallel	10.58

NOTE:

High-power AF Amplifier - 2
will be featured in our Nov'86 issue and not in this issue as mentioned earlier.

Publisher: C.R. Chandarana

Editor: Surendra Iyer
Editorial Assistance: Ashok Dongre
General Manager: J. Dhas
Advertising: B.M. Mehta
Production: C.N. Mithagari

Address:
ELEKTOR ELECTRONICS PVT. LTD.
52, C. Proctor Road,
Bombay - 400007, India

Overseas editions:

Gientop Publishers Limited
Standfast House, Bath Place
High Street, Barnet
London - EN5 1 ED

Editor: Len Seymour

Elektuur B.V.
Peter Treckpoelstraat 2-4
6191 VK Beek - the Netherlands
Editor: P. E. L. Kersemakers

Elektor srl
Route Nationale; Le Seau; B.P. 53
59270 Bailleul - France
Editors: D. R. S. Meyer;
G. C. P. Raedersdorf

Elektor Verlag GmbH
Süsterfeld-Straße 25
100 Aachen - West Germany
Editor: E. J. A. Krempelsauer

Elektor EPE
Karaiskaki 14
16673 Voula - Athens - Greece
Editor: E. Xanthoulis

Elektor JCE
Via Rosellini 12
20124 Milano - Italy
Editor: D. Furnagalli

Ferreira & Bento Lda.
R. D. Estefânia, 32-1º
1000 Lisboa - Portugal
Editor: Jorge Gonçalves
Ingelek S.A.

Av. Alfonso XIII, 141
Madrid 16 - Spain
Editor: A. M. Ferrer

International co-ordinating
& technical manager:
K. S. M. Walraven

The Circuits are for domestic use only.
The submission of designs of articles of
Elektor India implies permission to the
publishers to alter and translate the text
and designed to use the contents in
other Elektor publications and activities.
The publishers cannot guarantee to
return any material submitted to them.
All drawings, photographs, printed
circuit boards and articles published in
Elektor India are copyright and may not
be reproduced or imitated in whole or
part without prior written permission of
the publishers.

Patent protection may exist in respect of
circuits, devices, components etc.
described in this magazine.

The publishers do not accept
responsibility for failing to identify such
patent or other protection.

Distributors:
Blaze Publishers & Distributors Pvt. Ltd.

Printed At:
Triprint Offset
Bombay - 400 013



Copyright © 1986 Elektuur B.V.
The Netherlands

Television standards — what now?

Two important events took place this summer that will have a profound effect on TV broadcasting in the future. One, the *Peacock Report*, is of interest to Britain only and does not really deal with technological matters; the other, a CCIR motion, affects the entire western world. In true fashion, the first was given extensive publicity, the second hardly any at all.

The *Peacock Report* will probably affect television broadcasting in Britain for the remainder of the century. Although it contains many welcome recommendations, only one of these has a direct bearing on the design of TV receivers. Another, with some importance to the telecommunications industry, suggests that national telecommunication systems should be allowed to act as common carriers for a full range of services, including TV programmes.

Designers of TV receivers may have a busy time ahead in view of the proposal that all new television sets sold or rented in the United Kingdom should be adapted to receive direct subscription services by 1 January 1988.

It is interesting to speculate as to how such a direct subscription service would work. In all probability, it will entail a form of scrambling. Television sets would then have to be fitted with a special socket into which viewers would have to plug a decoder. Such a decoder, whatever form it takes, would cost the viewer money over and above the cost of the television set. Of the various decoding systems in existence, the one used by France's Canal Plus is probably the most cost-effective.

In the French system, a subscriber rents a keypad on which a personal number is keyed in. This number is changed monthly, so that the subscriber has to renew it twelve times a year at the appropriate fee.

Such a subscription service could not be introduced easily, particularly since the relevant equipment is not yet available.

Other than that, the report does not say much about the quality or technical requirements of television services. But then, that was not part of Prof. Peacock's brief, as politicians are not really interested in such minor matters.

From a technological point of view, a more important event was the lamentable decision by the European delegates at the *Comité Consultatif International de Radiocommunication* (CCIR=International Radio Consultative Committee) to reject a Japanese proposal, backed by the USA, for a world standard for high-definition television (HDTV) broadcasting (1125 lines; 5:3 aspect ratio; suitable for projection onto a large screen).

It appears that the Europeans were afraid that Japanese producers would dominate the world market for video equipment. Don't they already?

SEMIKRON

innovation + service

For Technical details
& Informations please contact:

IMR - TECH

(Consultants to Electronics Industry)

Tel: (022) - 642 -4191 (022) -642 -4902

Telex: 11 -71412 ALKA -IN

B. SEA BIRD, 114, B.J. Road,
Bandra, Bombay - 400 050

DC welding offers many advantages e.g. Constant mains load, Smaller transformers, Lower power consumption, Improved $\cos \phi$, Faster welding operations, Reduced splashing of metal- and faster welding. Even greater advantages to the above benefits are obtained through using the newly developed SEMIKRON power diode SKN 4000.

This device was specifically designed for welding applications and ensures:

- Much greater efficiency due to low forward voltage (typically 1 V at 10 kA).
- Greatly improved cooling because its low profile gives a large cooling surface.
- Superior protection against high current overloads $I^2t = 18 \cdot 10^6 A^2s$ and- $I_{SM} = 60 kA$
- High current rating of 4000 A at 600 V

HEAVY CURRENT OUR SPECIALITY

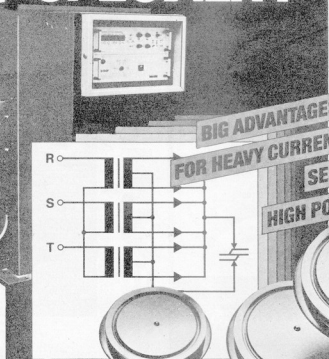

BIG ADVANTAGES

FOR HEAVY CURRENT APPLICATIONS

**SEMIKRON
HIGH POWER DIODES**

SEMIKRON Service brings: Block-package of power diodes SKWD 7000 with integral water cooling. For welding equipment we also supply:

- Water-cooled a.c. thyristors such as the SKW 1200/12 (1200 A_{av}).
- Standard ranges of diodes and thyristors.
- High-speed diodes, thyristors and transformers for frequency control.

Make a test installation of SEMIKRON power components to prove all the above advantages! For literature giving full technical data and characteristics write, phone or telex: SEMIKRON INTERNATIONAL Sigmundstr. 200 D-8500 Nürnberg 82 Tel. 09 11/65 59-1 Telex 622 155

CLEANLINESS — The Invisible Dimension of Quality — DISCOVER WITH KIRLOSKAR CLEAN AIR SYSTEMS.

**A must for Dustfree, sterile Atmosphere in
Electronics, Aeronautics, Engineering, Medical, Chemical and Pharmaceuticals.**

Clean Room

- Provides up to class 100 Clean Air over work areas.
- Clean rooms with air-conditioning as turnkey project
- Modular Tunnel Clean Room System offers several distinct advantages over traditional clean room designs.

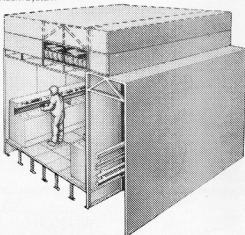

Air Shower

Fully automatic, electrically operated Kirloskar Air Showers are designed to provide high velocity air wash to remove all dust particles from clothing, foot-wear and other articles before entry into a clean room.

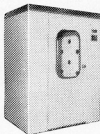

Clean Bench: Vertical/Horizontal

- Provides class 100 Clean Air, free from unseen dust particles and microorganisms, in work areas.
- Removes dust particles down to 0.3 microns with efficiency 99.97%



Electronic Cleaner

- Ideal for industrial and commercial use.
- Dust precipitation even to 0.1 micron particles
- Highly effective to control the dust level for suspended particles in the air.



Other Products

- Clean room accessories- as pass boxes, tacky mats, garment cubicles
- Clean room garments
- Air Curtains
- Chemicals benches
- Bio-hazard benches
- Packaged air-conditioners STR, 7.5 TR, 10TR
- Pressurising modules
- Fume hoods
- Electronic fume extractors

For Total Capability In Clean Air Systems

Please Contact:

**KIRLOSKAR
ELECTRODYNE
PVT. LTD.**



118, General Block, MID.C.
Bhosan, Pune 411026.
Tel: 86121, 86122, 86123,
86124, 84425
Telex: 146265 KEPLIN
Regional Offices at
Ahmedabad Tel. 77608
Bangalore Tel. 369556
Calcutta Tel. 470763 (Res.)
New Delhi Tel. 312131, 312152

MEETING THE NEEDS OF NEW GENERATION

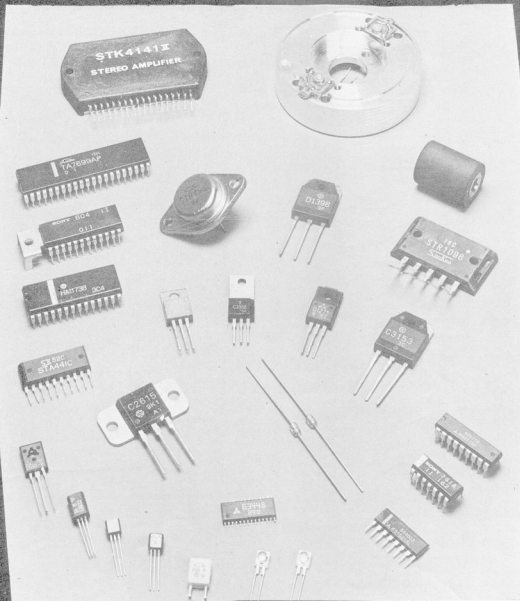

WE'RE SPECIALISTS IN REPLACEMENT PARTS

Some out of Data Semiconductors for Video, TV and Audio equipments or even the latest ones are very hard to get but this isn't a problem for us. We maintain an ample stock and we don't think. BIG only, small orders are also WELCOME. Stock list or Price list will not be provided, please send your specific requirements and we will quote our lowest prices immediately.

SMJ ELECTRONICS

SPECIALISTS IN: AUDIO VIDEO & COMPUTER COMPONENTS

52, Rajesh Bldg, 1st Floor, Opp. Police Station
339, Lamington Road, Bombay - 400 007, Ph: 363549

SATELLITE TV RECEPTION

by J & R v. Terborgh

Much has been said and written about satellite TV over the past few years. But what does this entail? Can anyone receive such programmes? What is the cost of a suitable installation? How does the law stand in regard to reception of these signals and the installation of the necessary equipment? In this article we will attempt to give answers to these questions and others, as well as give a theoretical appreciation and practical information on the subject.

Strictly speaking, the satellite is a repeater station: it receives the programme(s) from the TV studio via a suitable transmitter and then transmits it back to earth at a different frequency. Most existing and projected TV satellites travel in a geostationary orbit, that is, they remain always above the same point on the earth's surface (but see *Electric propulsion for satellites* elsewhere in this issue).

To receive the satellite signals, which are transmitted in the 10.9 to 12.5 GHz (giga-hertz=one thousand million hertz) band, a parabolic aerial, popularly called a dish aerial or just dish, is needed. The aerial must have an unobstructed view of that part of the sky where the satellite is located (these locations will be discussed later in this article). If the aerial is placed in the garden, even a small tree or washing-line post between satellite and receiving dish can ruin reception. It is possible to put the dish on the roof of a house, but this involves planning per-

mission (which is, we understand, not required for installation in the garden). Wherever the aerial is situated, it is important that it is fastened securely (most installation engineers recommend about 200 kg of concrete anchorage in the garden) to prevent its sailing away in high winds.

The aerial signal is fed to one or two down converters (depending on which programmes are to be received), which are mounted onto the dish. From there the signal is fed to the IDU (indoor unit) tuner, in which it is converted into a suitable video input to the conventional TV receiver.

Although the satellites are about 23000 miles away from the receiving aerial, the colour video signal (and teletext signal) is of excellent quality. In Britain, signals can be received from two different satellites: Eutelsat I - F1, commonly called ECS 1, and Intelsat V - F4. The first carries ten European channels (of which four in English), while Intelsat transmits four English-

language programmes. See also Table 2 in this article and *Elekto India*, March 1986, p. 3-25. When you want to switch from one satellite to the other, the dish has to be repositioned, and for this it is best to rent or buy a motor-driven aerial. Full programmes are given in the monthly *Satellite TV Europe* (£1.50).

Costs vary widely. Dishes may be rented from DER at an initial outlay of around £750. Complete systems cost from just over £1000 for a DIY outfit to over £3000 for one with a motor-driven dish. So far, the programmes discussed here are transmitted by communications satellites with spare capacity. The transmitters on board these satellites are of relatively low power, so that large (1.5 to 1.8 m diameter) receiving dishes need to be used. Many European countries are planning to launch a Direct Broadcasting Satellite (DBS) within the next few months. Such satellites have powerful transmitters, so that relatively small (less than 1 m diameter) dishes will suf-

fice to receive their signals. These smaller dishes will be much cheaper and much easier to install. The BBC had originally planned to launch their DBS service this autumn, but these plans had to be abandoned because of the enormous costs involved. Plans for a British DBS service are now being developed by the Independent Broadcasting Authority (IBA).

As regards direct reception of programmes transmitted by communications satellites, the law (at least in the UK) is not clear. Strictly speaking, no private individual is allowed to intercept communications transmissions, but the fact that the equipment to do so can now openly be rented or bought from reputable suppliers seems to indicate that in this instance the government does not intend to enforce the requirement: for a special receiving licence. Compared with terrestrial transmitters operating in VHF/UHF TV repeater band, TV satellites

1. have a much larger

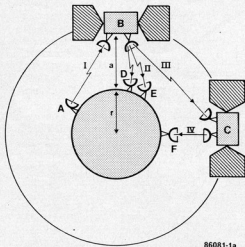

A = uplink station for TV and data comms
 B, C = geostationary satellites
 D, E = CATV/SMATV stations
 F = data reception station
 I = uplink (14/17 GHz; 70...95 dBW EIRP)
 II = downlink (11 GHz; 40...48 dBW EIRP)
 III = sat-sat cross strap (11GHz)
 IV = data downlink

not to scale

86081-1a

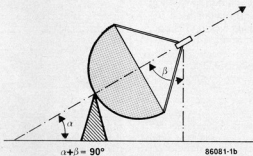

86081-1b

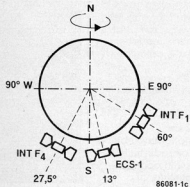

86081-1c

Fig. 1. Two geostationary satellites (1a) providing signals to stations that could not possibly be reached but with an extensive network of terrestrial transmitters. Figures 1b and 1c show how a dish aerial is pointed towards the satellite using angle of elevation α and orbital position with respect to the Greenwich meridian.

- coverage area (footprint);
- operate at frequencies of the order of 12 GHz rather than 50...850 MHz;
- employ FM rather than AM for the vision channels which consequently need a bandwidth of 27 to 36 MHz instead of about 7 MHz;
- may offer more programmes at a time whilst being capable of supporting enhanced multi aural subcarrier systems.

The present article is not intended to cover such topical subject aspects as economical viability of satellites as compared with terrestrial transmitter networks, launching schedules and arrangements (ESA, NASA), transponder leasing by international consortia, programme content, legal matters, and the cable vs. satellite debate. Neither will it explore details of technical operation, construction, and electro-chemical/electromagnetical positioning systems of modern satellites (but see *Electric propulsion for*

satellites elsewhere in this issue), although these would appear highly interesting subjects in view of the fast progress of international space technology and SHF engineering.

With the foregoing constraint as to subject matter in mind, it is instructive to investigate what can be received using a number of given system parameters. To this end, a draft may be made of a hypothetical TV satellite receiver system composed of what is currently considered to have representative characteristics; see Table 1. With this system on paper we will assess vision and sound quality by means of guided calculation.

As to the target satellite, Intelsat V F-4, which carries a mainly British payload, it should be made quite clear that this is a CSS (communication service satellite) intended to service cable network headend stations employing large (diameter ≥ 3.5 m) dish aerials and very sophisticated converter and transposer equipment. It is only the

recent development in GaAs (gallium arsenid) technology that has made it possible to receive this satellite with relatively small (diameter 1.5 m) dishes; LNB's (low noise block down converters) incorporating GaAs FETs as ultra low noise active devices are currently being offered at competitive prices, enabling private reception of the relatively weak satellite signal.

Not all terms used in Table 1 will be clear at a first glance, but they will be explained in due course. First, however, it is necessary to know the whereabouts of that tiny spot in the sky.

Spotting the satellite

The hypothetical receiver system just introduced may be considered either station D or E in Fig. 1a. It should be reiterated however that Table 1 specifies characteristics of a **private**, not a **community** (CATV/SMATV) receiver; the requirements for the latter

are far more stringent. The revolution time T_r for orbiting bodies such as satellites B and C is computed from

$$T_r = 1.40818333((a/r)+1)^{3/2} \text{ [h]} \quad (1)$$

where

a = altitude of body above equator [km];
 r = mean radius of earth; 6371 [km]

For the body to be geostationary it must travel at a velocity that results in $T_r = 24$ hours. From (1) it is seen that the requisite value for a is calculated as

$$24 = 1.40818333((a/r)+1)^{3/2}$$

$$((a/6371)+1)^{3/2} = 17.043236$$

$$(a/6371)+1 = 17.043236^{2/3}$$

$$a/6371 = 6.6227 - 1$$

$$a = 35\,822 \text{ km.}$$

The geostationary orbiting plane is already quite crowded with communication satellites, and regulatory action is called for on part of the WARC (World Administrative Radio Conference) to ensure orbital position spacing of not less than 0.2° (about 150 km), while a servicing (parking) orbit is being considered for spare as well as defective satellites at some 100 km further into space.

Although gravitational and centrifugal forces are at equilibrium in any orbit, satellites are none the less frequently repositioned by the relevant uplink control centre which obtains its information from monitoring telemetric stations. Such positional corrections are called for to compensate for satellite movement owing to fluctuations in the earth's magnetic field or possible collisions with stray galactic matter such as meteorites; consider that satellite span (solar cells) may be well in excess of 15 metres, while the absolute orbital velocity V_0 in synchronous orbit amounts to no less than

$$V_0 = 631.35\sqrt{(a+r)} \text{ [km/s]} \quad (2)$$

$$V_0 = 631.35\sqrt{(35822+6371)}$$

$$V_0 = 3.07 \text{ km/s}$$



Fig. 2. Rear view of a dish, fitted with the Polar Mount satellite tracking system which enables easy dish positioning for satellites at different orbital positions. (Photograph reproduced here by courtesy of Harrison Electronics)

Fig. 3. Showing the TV satellite uplink station at Lessive, Belgium. (Photograph reproduced here by courtesy of Regie Telefonie en Telegrafie Belgium)

Fig. 4. Basic operation and outlines of dish aerials for use on the 11 to 12 GHz band. The offset parabola shown at the left of Fig. 4c is an attractive alternative for reception of future DB satellites.

Given a specific orbital position of B, the receiver dish elevation angle α (see Fig. 1b) will need to be established for the relevant latitude of the receiver location within the satellite's service area. Obviously, α decreases as the location is further up north. Therefore, B may be received with, say, $\alpha = 22^\circ$ on the Orkney Islands ($\approx 58^\circ$ N) while $\alpha = 29^\circ$ on the Channel Islands ($\approx 49^\circ$ N). The requisite angle of elevation also depends on the orbital position of the satellite; if this is positioned at, for instance, 60° E (above the Indian

Ocean) like Intelsat V F-1 (see Fig. 1c), α is relatively small (about 10°) at receiver latitude 52° N. This means that the dish aerial should be located in such a manner that clear sight is ensured towards a point just above the horizon. It is evident that the actual distance to the geostationary satellite is more than 35 822 km at, say, 52° N, since allowance should be made for the sphericity of the earth and the fact that the orbital position may not coincide with the longitude of the receiver location. There exists a complex

relationship between orbital position, longitude, azimuth and angle of elevation, and this has been taken as the basis for the design of the so-called Polar Mount tracking system, the practical version of which is shown in Fig. 2. Once correctly adjusted, the system ensures correct tracking of the polar belt, allowing easy (motorized) pointing of the dish towards satellites at different orbital positions. Many suppliers of satellite receiving equipment can provide customer-specific charts or tables aiding in finding the correct combinations for elevation and azimuth.

With reference to Fig. 1a, it is seen that the term EIRP (effective isotropic radiated power) is used to specify equivalent transmitter power, which is the product of aerial gain factor G_a and transmitter output power P_0 , or the sum of these if expressed in dBs; EIRP is expressed in dBs relative to 1 W (dBW) or 1 mW (dBm):

$$\text{EIRP} = 10 \log_{10}(P_0 \times G_a) \text{ [dBW]} \quad (3)$$

Table 1.

TV satellite reception system

- **object satellite:** Intelsat V F-4 (27.5° W; $f = 11.5$ GHz; EIRP = +44 dBW).
- **aerial:** primary feed dish; 1.5 m diameter.
- **LNB parameters:** $F = 3$ dB max.; input loss = 1 dB (polarizer); conversion gain >50 dB.
- **receiver bandwidth:** 36 MHz.
- **ambient temperature:** 290 K ($\pm 17^\circ$ C).
- **system IF and total gain:** 950...1750 MHz at $G_c \geq 80$ dB.
- **download cable attenuation:** <4 dB.
- **unobstructed view to satellite position is assumed.**

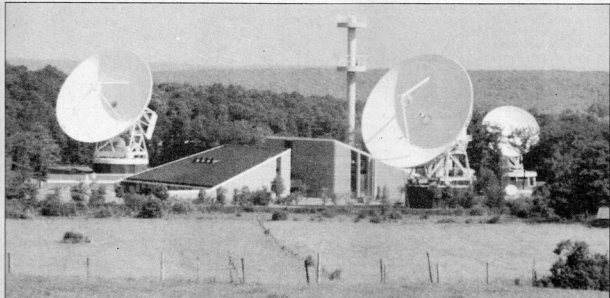

Example: $P_o=20\text{ W}$; $G_o=100$ times, then
 $\text{EIRP}=10\log_{10}(2000)=+33\text{ dBW}$ or
 $\text{EIRP}=+13\text{ dBW} + 20\text{ dB} = +33\text{ dBW} \hat{=} +63\text{ dBm}$.
 Obviously this is a convenient method of expressing relatively high or low power levels. If, for instance, downlink II is run at $+45\text{ dBW}$ EIRP, the equivalent power is $5\text{ dB} + 40\text{ dB} = 3.16 \times 10^4\text{ W} = 31.6\text{ kW}$, while uplink I is run at, say, $+92\text{ dBW}$ EIRP, or $2\text{ dB} + 90\text{ dB} = 1.6 \times 10^9\text{ W}$ or 1.6 GW . The former value is typically achieved with $P_o = 20\text{ W}$ and $G_o \hat{=} +32\text{ dB}$, while the enormous uplink power is ensured with $P_o = 500\text{ W}$ into an aerial 18 metres across exhibiting a gain of 62 dB . Figure 3 shows a view of the satellite TV uplink station.

System constituents

As the parabolic dish is probably the only suitable type of aerial to offer sufficient gain at frequencies above 2.5 GHz , its design and basic operation requires a brief discussion. Remember that our system uses a dish 1.5 m across. Figure 4 shows a number of dish types. The first one,

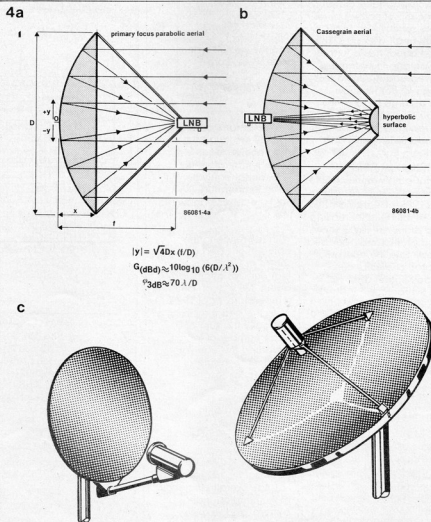

shown in Fig. 4a and referred to as the primary focus type, is probably the best known, and some of its basic design formulas are given inset with the drawing. The Cassegrain aerial (Fig. 4b) is a more sophisticated type exhibiting improved efficiency and easier LNB mounting at the focal point at the centre of the reflective surface. The offset aerial shown at the left in Fig. 4c is expected to become widely used in the future as it can offer higher efficiency than the primary focus type shown at the right. The reason for this lies in the comparatively large shadow the LNB mount and support rods throw onto the reflective surface of the latter; this effect becomes more serious with relatively small dish sizes. The offset aerial has a further advantage in being less curved and therefore less prone to gather snow if fitted at large (>35°) elevation angles such as may be required in, for instance, Switzerland and northern Italy.

To make clear that dish aerial gain with respect to a dipole (G_{2dB}) rises and half power beamwidth ($\varphi_{0.5dB}$) falls with increasing dish diameter, Fig. 5 shows a graph that may be used to estimate the relevant characteristics of our (hypothetical) dish, which is 1.5 m across.

The next item to be considered is the LNB (Table 1; Fig. 7). This is basically a high conversion gain, low noise device which transposes the 10.95...11.75 GHz band into an intermediate frequency (IF) of 950...1750 MHz, using a 10.0 GHz local oscillator. The 11 GHz amplifier stages as well as mixer and local oscillator are usually all-GaAs technology ensuring a low noise figure (3 dB), good stability over a considerable temperature range, and high IF gain.

The indoor unit, lastly, is a wideband FM TV tuner which accepts the IF

band and decodes vision and sound channels.

Receiver and system noise

In order to assess the final vision and sound quality of the set-up outlined in Table 1, a so-called *downlink budget* needs to be specified; basically, the parameters given in Table 1 are a sufficient help to consider details regarding the system noise vs. signal strength balance. Will the signals from about 38 000 km be clear or not?

The equivalent noise power any receiver produces at its input, $P_{N(r)}$, is calculated from

$$P_{N(r)} = kT_r BW \quad (4)$$

and the overall system noise, $P_{N(sys)}$, from

$$P_{N(sys)} = k(T_r + T_a)BW \quad (5)$$

where

k = Boltzman's constant; 1.38×10^{-23} J/K;

T_r = receiver equivalent noise temperature [K];

T_a = aerial equivalent noise temperature [K];

BW = receiver bandwidth [Hz].

With reference to the calculations and graph shown in Fig. 6, it is seen that our LNB attains a T_r of about 300 K at an ambient temperature, T_a , of 290 K. As to the aerial, T_a in (5) is basically the sum of a large number of factors, including the equivalent noise temperature of galactic, atmospheric, and man-made interference at the frequency of reception, while the relative degree of dish smoothness, its shape factor (surface irregularities $\leq 1/40\lambda$), reflective qualities, beamsquint, f/D ratio (see Fig. 4a), overall efficiency of illumination, side lobe pattern, and relative height above ground also play a distinct role. In general, commercially available dishes, if placed at a suitable "clear view"

5

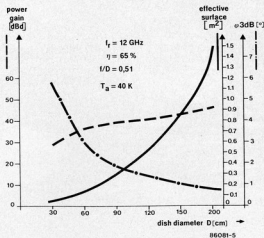

6

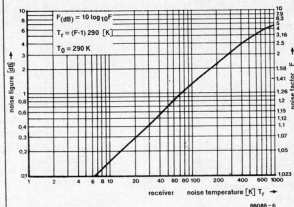

7

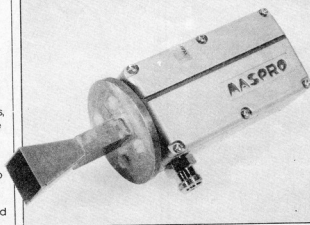

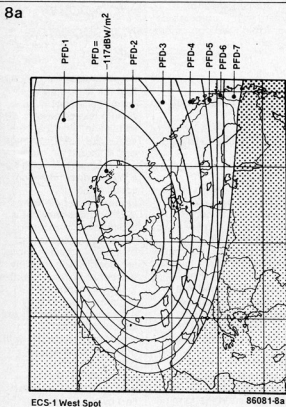
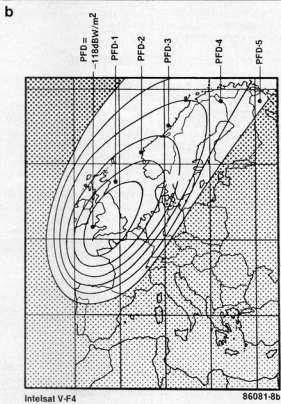

Fig. 5. This combination of curves enables a quick estimate to be made of primary focus dish characteristics, since it shows theoretical power gain with respect to a $1/2\lambda$ dipole, effective surface and 3 dB directivity as functions of dish diameter.

Fig. 6. Showing how equivalent receiver noise temperature is calculated and plotted as a function of either F_{as} or F .

Fig. 7. Example of a CSS LNB fitted with a horn feed to ensure correct illumination of a dish dimensioned for $D/\lambda = 0.5$.

Fig. 8. PFD contours (footprints) of Eutelsat 1 (ECS-1) and Intelsat V F-4. Note that the former produces a higher PFD than the latter.



location, can be expected to have T_a values of 40...50 K; the better the aerial, the lower T_a . With system parameters $T_r = 300$ K, $BW = 36$ MHz and T_a estimated at 45 K, (4) and (5) show that

$$P_{R01} = 14.904 \times 10^{-14} \text{ W} \triangleq -128.27 \text{ dBW} = -98.27 \text{ dBm}$$

while

$$P_{R02} = 17.1396 \times 10^{-14} \text{ W} \triangleq -127.66 \text{ dBW} = -97.66 \text{ dBm}$$

The theoretical threshold voltage, U_{min} , this receiver (i.e. the LNB, not the system) can detect is calculated from

$$U_{min} = \sqrt{R P_{R01}} \quad (6)$$

which, with $R = R_{in} = Z = 50$ ohm gives $U_{min} = \sqrt{50 \times 14.904 \times 10^{-14}} = 2.73 \mu\text{V}$.

Now that we have established the figures working on the negative side of the balance, let us proceed with calculating

how much the Intelsat V F-4 signal counterbalances the system noise.

Catching picowatts

The theoretical path loss, l , relevant to a line-of-sight link between two stations spaced d kilometres and operating at about 11 GHz is approximated by

$$l \approx 114 + 20 \log_{10} d \quad (7)$$

The figure 114 is an empirically established, sufficiently conservative factor that does, however, not include any additional attenuating influences such as heavy rainfall, snow, hail, fog, passing aircraft or sudden disturbances in the relevant section of the atmosphere. The additional attenuation caused by adverse weather conditions may rise to as much as 0.6 dB/km, while meteorite showers and satellite positioning errors cause an even more dramatic increase of l . If it

is known that (7) gives us $l \approx 114 + 20 \log_{10} 38800 = 205$ dB

for reception of Intelsat V F-4, it should be remembered that some 210 dB may be a more practical value in view of the prevailing weather conditions in most of western Europe.

In many instances of adverse weather conditions, either an automatic signal strength monitoring system, the relevant CATV/SMATV authorities, or even the transponder leaseholder may arrange for a logo to be shown notifying viewers of the possibly impaired vision and/or sound quality.

With Intelsat V F-4's EIRP of +44 dBW and $l = 205$ dB, a so-called isotropic aerial, which is a hypothetical reference device offering unity gain ($G = 1 \triangleq 0$ dB), would receive a power level of

$$\text{EIRP} - l = (44 - 205) = -161 \text{ dBW} \quad (8)$$

If located at the centre of

the satellite's downlink beam on the earth's surface. Since an isotropic aerial has an effective surface area, S_{iso} , of

$$S_{iso} = \lambda^2 / 4\pi \quad [m^2] \quad (9)$$

which on 11.5 GHz ($\lambda = 0.025 \text{ m} = 2.5 \text{ cm}$) gives $S_{iso} = 4.97 \times 10^{-5} \text{ m}^2$. Since this isotropic surface offers unity gain, a real aerial with an effective surface of 1 m^2 must have a power gain G of

$$G = 10 \log_{10}(1/S_{iso}) \quad [\text{dBi}] \quad (10)$$

which in the present case gives $G = 10 \log_{10} 20107 \approx +43 \text{ dBi}$. Note the difference between G and G_{dipole} ; the terms are relative to an isotropic and a dipole aerial respectively, while $G_{dipole} = G + 2.15$.

On an effective surface of 1 m^2 the satellite thus produces a power flux density (PFD) of

$$\text{PFD} = G + \text{EIRP} - I \quad [\text{dB(W/m}^2)] \quad (11)$$

and so in the present case $\text{PFD} = +43 + 44 - 205 = -118 \text{ dB(W/m}^2)$.

The PFD is a measure of relative signal strength in satellite reception technology and system planning. In Figs. 8a and b, PFD contours (footprints) have been drawn for the elliptical beams produced by ECS-1 and Intelsat V F-4 respectively.

It is readily seen that increasing the effective aerial surface is the only means of compensating for the lower PFD values in areas bounded by PFD contours PFD-1 to PFD-6. If you happen to live in the latter, you "simply" need an extra 6 dB of aerial gain to get the same quality of reception as in the centre footprint; using the same receiver, of course. Refer to Fig. 5 once more to see what increase in dish diameter would be required to accomplish this, and you can understand why CATV/SMATV headend stations use very large dishes ($D > 3.5 \text{ m}$) to

cope with less than favourable weather conditions.

Downlink budget

The foregoing paragraphs have led to two important figures which counteract and thus form weights on the carrier-to-noise (C/n) balance:

$$C/n = \text{PFD} - (P_{\text{noise}}) \quad [\text{dB}] \quad (12)$$

which in our case goes down in favour of the carrier weight:

$$C/n = -118 - (-127.66) = +9.66 \text{ dB}$$

This figure is not bad at all, considering that CATV/SMATV authorities demand approximately +15 dB for their set-up, which necessarily includes a 3...5 m dish. In practice, $C/n \approx 10 \text{ dB}$ has proved to be a satisfactory value for private reception.

Figure of merit

It ought to be recalled here that both U_{min} and C/n have a bearing upon the RF input of the system; they provide neither a direct measure for, nor any conclusive information about, what happens at the indoor tuning unit's output, i.e. on the colour TV set.

Manufacturers of TV satellite receiving equipment generally use the figure of merit, expressed as the gain-temperature ratio G/T to specify the relative quality of their

system:

$$G/T = 10 \log_{10} \left[\frac{G}{\sigma T_a + (1-\sigma) 290 + T_r} \right] \quad [\text{dB/K}] \quad (13)$$

Where

G = aerial gain (power factor, not in dB);
 σ = sum of losses between preamplifier (LNB) input and point of maximum PFD in aerial system (power factor, not in dB).

For our hypothetical system with parameters as per Table 1 we can assess G/T at

$$\begin{aligned} G/T &= 10 \log_{10} \left[\frac{20,000 \times 0.8}{0.8 \times 45 + (1 - 0.8) 290 + 300} \right] \\ &= 10 \log_{10}(16,000/394) \text{ dB/K} = \\ &16.1 \text{ dB/K,} \end{aligned}$$

provided of course, that the overall conversion gain is high enough (which condition seems to be satisfied with G_c at 80 dB) and that the input noise figure of the indoor unit is not more than about three times that of the LNB (see literature references [1] and [2]). The calculation of G/T shows quite conclusively that pre-LNB losses (σ) can degrade the overall system performance to a very high extent; all attenuation in the form of filters, polarizers or lengths of waveguide fitted to the LNB input may have a detrimental effect on the system sensitivity, just like the moth sheltering against the rain in the feed horn of our LNB (Fig. 7); reception was only restored to normal after the insect had been removed.

The signal-to-noise ratio, S/N , is, finally, a measure of vision quality at the receiver system output:

$$S/N = \text{PFD} + G/T + x \quad [\text{dB}] \quad (14)$$

In which x is generally given as 147.3 dB for systems operating at a bandwidth of 36 MHz (Literature reference [7]). Our equipment therefore offers $S/N = (-118) + 16.1 + 147.3 = 45.4 \text{ dB}$ which is more than adequate for excellent vision and sound quality, as proven by Fig. 14. Tuning across the transponders on Intelsat V F-4 reveals a channel assignment as shown in Table 2a, while Table 2b shows the programmes carried by ECS-1.

High-power transponders: DBS

It has already been noted that the foregoing calculations apply to private reception of a satellite intended to service CATV/SMATV systems, and it should be clear by now that receiver dish size is highly dependent on satellite EIRP.

Planned as early as in 1972 and assigned their orbital positions during WARC 1977, DBSs (direct broadcast satellites) have, regrettably, become the subject of heated debates in which technical arguments are rapidly superseded by the wildest speculations about programme content, overspill capacity of downlink beams, and exotic modulating systems intended to make reception as costly as possible. Scrambling is often wrongly identified with the D2-MAC system, which has, in fact, been developed with entirely different aims in mind and which is basically but an enhanced version of existing PAL/SECAM standards.

All of these speculations are quite premature, since the first pair of European DB satellites are not due for launching until later this year (both Russia and Japan already have DBSs in operation), and it will take controlluplink centres at least half a year to complete extensive test procedures.

As to the mandatory minimum PFD level DB satellites must be capable of producing within the centre footprint, RARC 83 (region 2, the Americas) relaxed the original $-103 \text{ dB(W/m}^2)$ requirement stipulated by WARC 1977 to $-107 \text{ dB(W/m}^2)$, thereby formally recognizing the rapid progress in SHF semiconductor technology over roughly 6 years. It was also agreed that a C/n ratio of 14 dB and a figure of merit $G/T = 10 \text{ dB/K}$ should be

Table 2a.

Intelsat V F-4

orbital position: 27.5° W

EIRP: +44 dBW

channel bandwidth: 70 MHz

transponder No., beam, polarization	programme	country/countries	frequency [GHz]	scrambling system	total bandwidth [MHz]	pre-emphasis	dispersal [MHz _{pp}], (fd)	vision system
1 W -	-	-	10.975	-	-	-	-	-
2 W H	Premiere/ The Children's Channel	UK	11.015	none	30	CCIR 405	2 (25 Hz)	PAL
3 W H	Screen-Sport/Arts Channel/ Lifestyle	UK	11.135	none	30	CCIR 405	2 (25 Hz)	PAL
4 W H	test chart	-	11.175	none	30	CCIR 405	2 (25 Hz)	PAL
5 W -	-	-	11.515	-	-	-	-	-
6 W -	-	-	11.565	-	-	-	-	-
1 E -	-	-	10.995	-	-	-	-	-
2 E V	CNN	USA	11.155	none	30	CCIR 405	2 (25 Hz)	PAL
3 E -	-	-	11.475	-	-	-	-	-

All data subject to change.

Table 2b.

Eutelsat 1 F-1 (ECS 1)

orbital position: 13° E.

EIRP: +45.0 dBW.

channel bandwidth: 72 MHz.

transponder No., beam, polarization	programme	country/countries	frequency [GHz]	scrambling system	total bandwidth [MHz]	pre-emphasis	dispersal [MHz _{pp}], (fd)	vision system
1 W H	RAI-1	Italy	11.005	none	36			PAL
2 E H	3-SAT	Germany Austria Switzerland	11.055	none	36			PAL
3 W H	Europe TV (EBU)	Holland	11.170	none	36			PAL (D2-MAC)
4 W H	TV-5 or Worldnet	France or USA	11.470	none	36	CCIR 405	2 (25 Hz)	SECAM PAL
5 - -	-	-	-	-	-	-	-	-
6 W H	Sky Channel	UK	11.650	OAK- RACAL	27			PAL
7 W V	Teleclub	Switzerland	10.985	none	36	CCIR 405	4 (25 Hz)	PAL
8 E V	RTL plus	Luxemburg	11.085	none	36			PAL
9 W V	ATN - Filmnet	Holland & Belgium	11.138	none or experimen- tal	30			PAL
10 W V	SAT-1	Germany	11.507		36			PAL
11 - -	-	-	-	-	-	-	-	-
12 W V	Music Box	UK	11.674	none	36/30			PAL

All data subject to change.

target design values for individual receivers. (Literature reference [6]). Figures 9 and 10 summarize a part of what was agreed upon during WARC 1977, although it must be pointed out quite clearly that these are but **recommendations** to individual countries of which, at present, only France (**TDF-1**) and Federal Germany (**TV-Sat**) are on the verge of putting a national DBS in orbit; the EBU (European Broadcasting Union) intends to have ESA launch the *Olympus (L-Sat)* DBS which is to have a very large pan-European beam (see Fig. 11). The Scandinavian **Tele-X** is probably the next in line, while Italy, Ireland, Luxemburg, and Switzerland have their projects still in the planning stages.

To understand why DB satellites can be received by relatively small dishes (60...90 cm across) and low-cost LNBs for the 11.7...12.5 GHz band, you need merely interpret the foregoing calculations in the knowledge that the EIRP levels of these transponders will be of the order of 60...65 dBW (1 to 7 MW, $P_0 \approx 275$ W), ensuring good signal strength within the relevant coverage area.

With these PFD and EIRP levels, and using a 1.5 m dish, the *S/N* and *C/n* of our hypothetical receiver (slightly modified to suit the somewhat higher DBS frequencies) would be improved by no less than about 15 dB. The dish could, therefore, be reduced to around 75 cm diameter and still give a more than adequate signal for high-quality sound and vision.

The D2-MAC/Packet system (D = data transmission; 2 = bitrate division factor with respect to C-MAC; MAC = multiplexed analogue components, i.e. luminance and chrominance signals are separately stored and processed; Packet = digital coding of aural subcarriers) is claimed to offer a

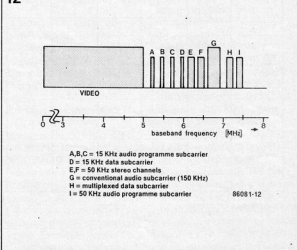
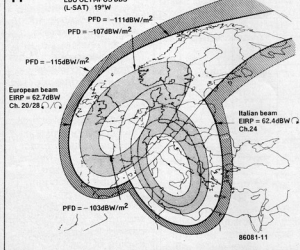
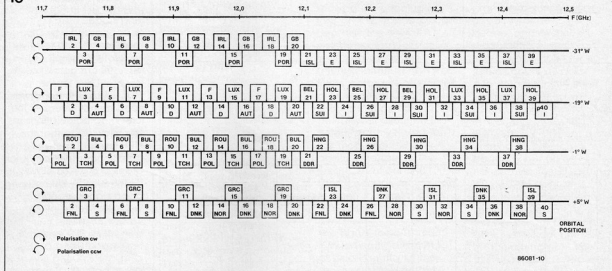
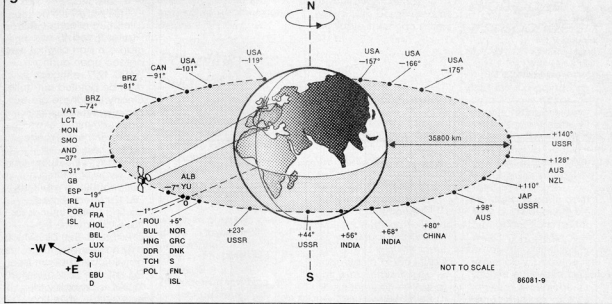

Fig. 9. WARC 77 assignment of orbital positions for a number of DB satellites. Not shown are CS satellites already orbiting the earth at sometimes very low spacings, crowding the available room above the equator.

Fig. 10. WARC 77 assignment of channels within the DBS band and associated polarization standard. Note that a single frequency may be occupied by two transponders, provided these employ different polarization directions.

Fig. 11. Projected footprint of the EBU DBS called L-Sat. PFD = -115 dBW/m^2 contour represents the limit of community reception, while PFD = -103 dBW/m^2 should enable excellent reception by privately owned receiver systems. TDF-1 and TVSat are expected to produce even higher PFD levels within their necessarily smaller elliptical coverage areas. (Courtesy of EBU Brussels)

Fig. 12. Example of a DBS baseband signal, i.e. unfiltered frequency spectrum at the output of the system's FM demodulator.

Fig. 13. This is what may be required to receive future DBS transmissions, provided the site is located within the relevant service area (footprint) of the satellite.

Fig. 14. The system referred to in this article is in fact not hypothetical at all; these photographs were taken to prove that reception of ECS-1 is quite adequate given the limited means as compared with cable distribution headend stations. The indoor unit as part of the system will be described in next month's issue of this magazine.

further improvement of about 2 dB SIN as compared with conventional PAL/SECAM coding, while being recognized as capable of supporting multiple aural subcarrier

arrangements such as the one shown in Fig. 12. Multi-language transmissions (EBU), as well as, for instance, VCR timekeeping and high-quality stereo programmes (compressed bandwidth systems like Panda-Wegener), public data services and Teletext over satellite. . . no wonder DB satellites are expected to become a revolutionary force in the TV era just ahead of us. Next month we will publish the first part of a design for an Indoor Tuning Unit for satellite TV reception.

Literature references

- [1] Lenz R, DL3WR: *Noise in receiver systems*. VHF Communications 4-75.
- [2] *Aerial amplifiers*. Elektor Electronics (UK), February 1980.
- [3] Kernot, R J: *The use of the European communication satellites for television transmission*. Source: see [4].
- [4] Scott, J M C and Neusten, M: *Experience of accessing Eutelsat transponders from transportable earth-stations*. Colloquium of the Electronics division of the IEEE, digest No. 1986/32.
- [5] Evans, D S and Jessop, G R: *VHF-UHF manual*. Third edition; The Radio Society of Great Britain (RSGB).
- [6] *EBU review (technical)*: several articles in issue Nos. 200, 202 and 215.
- [7] *Kathrein Haus & Antenne*, English edition 1985.
- [8] *Satellite TV receiving equipment*. Elektor India, March 1986.

Bu

Since T is the international symbol for both *period* and *thermodynamic temperature*, it is used with these different meanings in formulas 1 and 5 respectively. Similarly, a is used for altitude in formula 1 and for sum of losses in formula 13. (Ed)

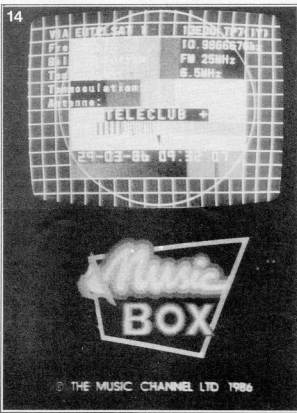
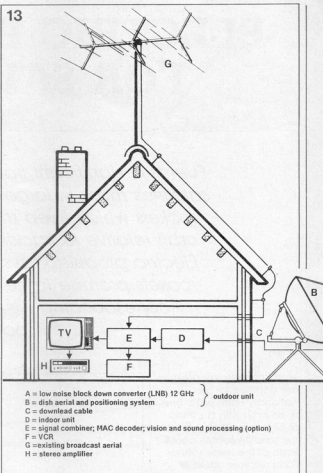

ELECTRIC PROPULSION FOR SATELLITES

by Dr Anthony Martin, Culham Laboratory, Abingdon, Oxfordshire.

Fuel is a significant fraction of a communications satellite's mass. A large part of it is needed for the rockets which keep the spacecraft stationary in orbit relative to tracking stations on the ground. Electric propulsion systems to replace chemical rockets promise large savings in fuel mass, with correspondingly greater communications payloads.

Most commercial satellites are destined for geostationary Earth orbit. That is, an orbit with a period of 24 hours, which means the satellite rotates about Earth at the same rate as Earth revolves about its axis. The satellite will then appear to be fixed in the sky, so the antennas receiving its signals do not have to be steered or moved to track it. The greater part of Earth's long-range communications are now routed this way, including inter-continental telephone calls, and television from the other side of the world is familiar on our screens. Plans are already well advanced for direct broadcasting satellites which will relay signals with such a high power that they can be picked up by a relatively small dish antenna in the home, bypassing the need for large receiving stations. But an uncontrolled satellite would not remain fixed in its 24-hour orbit for very long. Because the gravitational pull of the Sun and the Moon on a satellite distorts its orbit, it would wander about the sky and make tracking difficult. This effect has to be

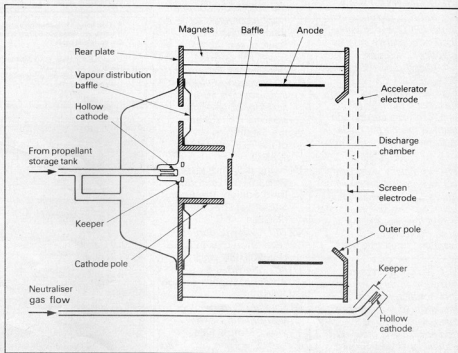

corrected by using an on-board propulsion system to correct the velocity by about 50 metres per second in one year. So, orbit control to keep a satellite 'fixed' in the sky or 'on station' is essential and the satellite must be able to provide this. Indeed, ability to correct the orbit may often decide the useful lifetime of the

satellite: once it is unable to keep station, the communications payload is switched off and the satellite is abandoned.

Propulsion systems

Any orbit control system must be reliable and have a long life, which means

Schematic layout of an electron bombardment ion engine.

about 10 years for modern spacecraft. It should also weigh very little, for every kilogram that is not used for payload reduces the revenue that the satellite earns.

Satellites now in service use chemical rockets for orbital control. The propellants used are allowed to react in a rocket chamber and the products from the reaction are expanded through a nozzle to produce a jet of fast-moving gas. The velocity of the jet, or exhaust, which the propulsion system can achieve is important. The amount of propellant that has to be used to provide the 50 metres per second change in velocity is related exponentially to the ratio that the velocity change bears to the exhaust velocity. The higher the exhaust velocity, the lower the mass of propellant that must be carried to keep the satellite on station.

Monopropellant rockets have exhaust velocities of about 2.2 kilometres per second and, for a 10-year mission, must carry 200 grams of propellant for every kilogram of satellite mass at the start of operations. Bipropellant systems have an exhaust velocity of about three kilometres per second, which means they must carry about 150 grams of propellant for every kilogram of satellite, but at the expense of a heavier, more complex rocket system.

Electric propulsion

However, the energy available from a chemical reaction is limited. To reach higher exhaust velocities, the source of energy must be decoupled from the propellant. It is here that electric propulsion systems offer an alternative to chemical rockets. Electric power is used to accelerate propellant to

much higher velocities, in the range of 30 to 40 kilometres per second. That means only 12 to 17 grams of propellant are needed per kilogram of satellite mass. Of course, the mass of the electric rocket and its power supplies must be reckoned as part of the propulsion system, but even so it can be seen that the mass gains possible with this type of system are very large.

The case of a 2-tonne satellite, typical of those that will be used for the most important communications links until the end of the century, can be used to illustrate the point.

The main propulsion requirement that has to be satisfied is the ability to provide a velocity change of 50 metres per second every year for station keeping and a further 60 metres per second at the beginning of the mission to place the satellite in the correct initial orbit. If an electric propulsion system were used to carry out these manoeuvres, gains in the payload fraction of about 25 per cent could be realised, compared with the mass that would be needed by a chemical propulsion system with its much greater need for fuel. To emphasise this figure, the

Comparison of electric propulsion with chemical rockets, for a 10-year North-South station-keeping duty. Data are for a two-tonne geostationary satellite, with initial station acquisition and 50 metres per second velocity change per year.

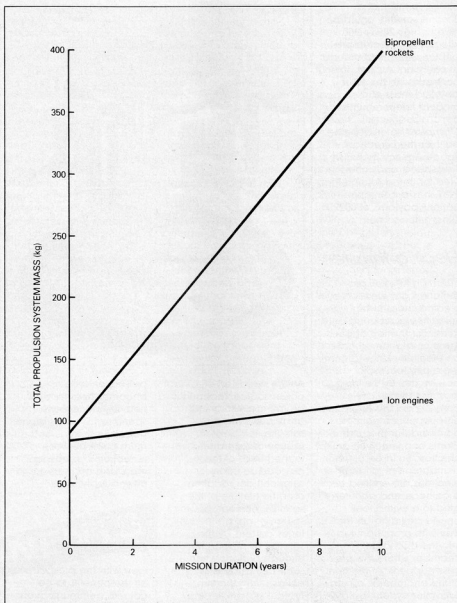

saving in mass of a 2-tonne satellite could be as much as 280 to 300 kilograms if electric propulsion were used instead of chemical rockets. This contrasts with the total payload mass of a modern telecommunications spacecraft. The *Olympus-1* satellite being built for the European Space Agency by British Aerospace, and scheduled for its first launch in 1987, has a communications payload of 307 kilograms.

Electric thruster

In an ion thruster, propellant is accelerated by electric forces to high velocities to produce thrust. For this to happen, the propellant must have an electron removed from the atom, leaving a positive ion. By far the most flexible means of carrying out this ionisation process is for electrons to bombard the propellant atoms and knock off an electron. So in an electron bombardment ion thruster electrons are emitted from a cathode and accelerated to a cylindrical anode, colliding on the way with propellant fed into the discharge chamber where the process happens. At the front of the chamber is an ion extraction system, usually consisting of two grids with a large number of small holes drilled in them. An electric potential, usually in the range of 1000 to 1500 volts, is applied across the grids, thereby causing the ions to be pulled from the discharge and accelerated through the second grid to form the beam. If only the ions were extracted from the discharge, the satellite would build up a large negative charge very quickly. So a neutraliser is included, to eject electrons and balance the charge on the spacecraft. All the foregoing has to do with the thruster part of the system. But a complete



The UK 10-centimetre diameter ion thruster, designed for station-keeping of multi-tonne communications satellites, now being tested with xenon propellant.

system needs an electrical power source. That might be the main solar-cell array powering the satellite. The array is usually oversized relative to the needs of the payload, to allow for solar-cell degradation over the lifetime of the satellite. Alternatively, the source might be the batteries carried by the satellite to support it through periods when the solar cell array is in eclipse from the Sun. Typical stationkeeping thrusters need a few hundred watts of power to operate them, which is a small fraction of the several kilowatts which are available on board large communications satellites. The need to draw power from the spacecraft, rather than from the chemical reaction of conventional rockets, governs the design of the propulsion system as a whole. High exhaust velocities, achieved by high accelerating voltages, reduce the amount of propellant needed. But they also mean that the power unit, which converts the output from the solar array or battery to the voltages required by the electric

propulsion system, becomes heavier and heavier with a corresponding need for higher power. So there is an optimum point between a reduction in propellant mass and an increase in powersupply mass.

Future propulsion

Even with the prospects of all the benefits to be gained, communications satellites still do not use electric propulsion, but rely on chemical rockets. Why? There are several reasons. Although electric propulsion systems are capable of increasing the payload by 20 to 25 per cent on a wide variety of satellites, it is only recently that communications spacecraft with masses of more than one tonne have become relatively commonplace. Previous generations of vehicles had masses of about 750 kilograms and the extra payload that might have been added was not considered enough to warrant the cost of developing the propulsion system.

It is only quite recently that communications satellites with powers of several kilowatts have become operational. Electric propulsion systems would absorb a small fraction of the total power available, in contrast to earlier available powers of 500 to 1000 watts; the propulsion, appeared to require too large a fraction of that lower power to gain easy acceptance. Also influencing acceptance are natural resistance to change and reluctance to adopt what is often seen as a complex system of strange thrusters, power supplies and controls, compared with the chemical rockets which might be thought relatively simple because they are so familiar. It is only recently that the benefits from such a change have become so potentially great as to compel this attitude to be rethought. One major objection to the use of electric propulsion has been the choice of propellant for most of the work carried out on thrusters, namely mercury. It is almost ideal as a propellant because it is heavy, dense and easily

stored. But it is not an ideal material as far as spacecraft designers are concerned, for it amalgamates rapidly with many metals such as copper, gold and aluminium, which means that the spacecraft structure, electrical wiring, power-producing solar cells and so forth could all be vulnerable to attack. Another problem with mercury is to do with the fact that it is liquid at normal temperatures. Care must be taken to heat the propellant to a vapour before introducing it into a thruster, and to keep it as a vapour. If it condenses, it could lead to breakdown of high voltage insulation, shorting out of power supplies, damage to solar cell arrays and other serious problems. All these disadvantages and problems with propellant are eliminated, or at least greatly reduced, if a gas is used instead of a liquid metal. The favoured candidate is the rare gas xenon, which is inert. It does not contaminate or react with the elements of

space systems so it removes most worries about the structural integrity of long-life spacecraft. It does not condense upon components, so it does not cause electrical trouble. The power supply systems are simple, too, for no supplies are needed to heat and vaporise the propellant. That means better system reliability. The problems of economic justification and power requirements hitherto associated with electric propulsion have diminished in importance, while those to do with choice of propellant and complexity of power supply have been reduced by thruster developments, so the time is ripe for this novel propulsion technique. A very successful programme of work on the development of electric propulsion systems, led by the UK Royal Aircraft Establishment at Farnborough in collaboration with Culham Laboratory and several industrial firms, ended in 1978. The reasons for not continuing

further had nothing to do with any failing in the systems that had been developed, which were at least as advanced and efficient as any others, but with the economics and other arguments to do with small, low powered spacecraft which I have already outlined. The programme has now been re-activated with a view to providing ion thrusters for station-keeping of multi-tonne satellites. The work is based around thrusters of 10 centimetres diameter operating with xenon propellant instead of mercury. How far development reached in the previous programme is shown by the fact that the same thrusters are being used; the only modification needed was to remove components that were used to vaporise the mercury and keep it in vapour form. Present plans call for a test flight on board a satellite in 1989, and commercial implementation soon after. Britain is not alone in such work, of course: all the leading space nations are

planning to test electric propulsion systems in the next few years. The USA is due to fly a satellite with two mercury devices. Japan has already flown a small mercury system and operated it for 200 hours in space, and is developing a 12-centimetre xenon system. Germany has plans to fly a 10-centimetre xenon system for a six-month test on the European Retrievable Carrier (EURECA). With so many contenders it is obvious that electric propulsion is about to come of age and find more and more application in the 1990s. The focus of work will then shift away from the proof-principle of a new propulsion system and concentrate more upon providing the most efficient, flexible and commercially attractive product for commercial users. Though electric propulsion will have been a long time coming, it will soon be here to stay.

COMPONENTS

For the construction projects in *Elector*, India we try to use 'standard' components wherever possible. This may not always be obvious at first sight, so some further explanation is given here.

Diodes

The 1N4001, 1N4004 and 1N4005 are rectifier diodes rated at 100 V, 600 V and 800 V respectively. The 1N4148 is a general-purpose silicon diode. The OA95, AA118 and AA119 are small-signal Germanium diodes.

A large number of equivalents are available for all these types. This is made even more explicit when a 'DUS' or 'DUG' is specified; the minimum specifications for the latter devices are given on the 'TUP-TUN' page.

Transistors

'TUP' and 'TUN' are indications for a large group of general purpose PNP and NPN transistors. The specifications are given on the 'TUP-TUN-DUG-DUS' page, as well as a large number of examples. Other suitable types are the HEF 50011 (PNP) and the 50013 (PNP) or the RS2010 and RS2016 (PNP) and the RS2022 and RS2034 (PNP). Note the slightly different connections to the 'RS' types! A further large group of very similar devices are the BC177 (B), BC157 (A,B), BC259 (C) (all PNP) and the BC237 (B), BC474 (A,B), BC549 (B,C) (all NPN). The specifications for these devices, and a long list of equi-

valents, are also given on the 'TUP-TUN' page. Generally speaking, if the last digit is a 7 a high-voltage type is required, whereas if the last digit is a 9 a low-noise type is indicated. The suffixes A, B and C indicate the current gain. Some other equivalents are the HEF types 50015 (for the BC237 and 547) and the 50019 (for the BC177 and 557). However, these HEF types have a different pinning; the emitter and collector are interchanged (as with the RS types mentioned above), so they have to be mounted 'back-to-front' on the EPS p.c. boards. Where a higher current gain is specified (B or C type), the 50024 (NPN) or 50031 could be used — once again, collector and emitter are interchanged — provided the maximum collector current (50 mA) is not exceeded. HEF equivalents for some other types used in *Elector* circuits are as follows: AF239; G0803; BC140; BC142; S3011; BC140; S3012; BC517; 89100 (emitter/collector transposed); BC546; no direct equivalent, however in most cases an 50024 can be used; BC556; 50026 (emitter/collector transposed); BD137; S3011 (note the different pinning); BD241; 85000 (or TIP291); BD242; S5006 (or TIP307); BF259; BF494; BF166; no direct equivalent — basically, these are low voltage, low current, low gain high frequency devices. The transistor list elsewhere in this issue may be used as a guide when looking for other equivalents.

ICs

Generally speaking, the TTL ICs, CMOS ICs and linear ICs are all fairly standard types. The pinning of some common linear ICs is published at regular intervals. Note that the letter prefix to the type numbers is often omitted (this usually denotes the manufacturer). '3911', for

instance, would actually be supplied by one manufacturer as 'LM3911'. Similarly, a '741' would actually be stamped μ 741, LM741, MC741, M1C741, RM741, SN741, etc. Of course, when special types are used for the very reason that they are special, availability may be a problem. Examples of this type of thing are the AY-3-5500 (General Instruments), SL440 (Plessey), TDA2002 (SGS/ATES), UAA170 (Siemens) and 4151 (Raytheon).

Resistors

Unless otherwise specified, resistors are 5-watt 5% carbon types. A 10% tolerance type is usually also permissible, with only a minor effect on performance. Values are specified using 'K' for 1,000 Ω and 'M' for 1,000,000 Ω ; the decimal point is replaced by either 'R' or 'E' or 'M'. So 4k2 is 4.7k; 4k7 is 4700 Ω ; 4M7 is 4700000 Ω .

Capacitors

The DC working voltage of capacitors (other than electrolytics) is normally assumed to be at least 60 V, unless otherwise specified. Values are specified using 'p' for 10⁻¹², 'n' for 10⁻⁹ and ' μ ' for 10⁻⁶. As with resistors, the decimal point is replaced by one of these letters. This means that 4700pF, for instance, is written as '4n7', not as 0.0047 μ F!

U, not V

The international letter symbol 'U' is often used for 'voltage'; 'V' is normally reserved for 'volts'. For instance: $U_0 = 10V$, not $V_0 = 10V$.

LOUDSPEAKER IMPEDANCE METER

by K. Rohwer

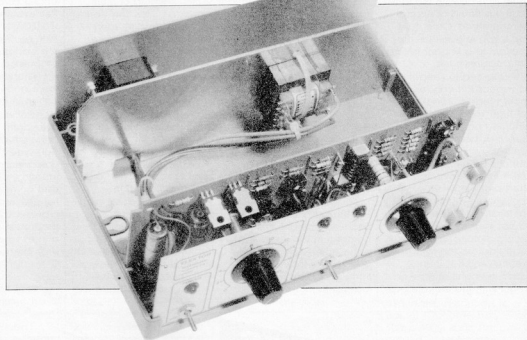

A simple, yet interesting and useful, instrument for measuring the resistance and the inductive reactance of a loudspeaker.

It may be argued that a loudspeaker impedance meter is something that is needed only once in a blue moon, but to many dyed-in-the-wool audio constructors it could be a godsend. Loudspeakers are frequently offered for sale at very low prices by various retailers, but often there is no indication as to their characteristics. The present circuit will at least enable the impedance to be ascertained with a good degree of accuracy. A multimeter will, of course, only give some idea of the resistance. A useful aspect of the present circuit is that the resistance and the inductive reactance can be measured separately. The only limitation of the meter is that all measurements take place at a frequency of 1000 Hz. This is an excellent value for woofers and broad-

band drive units, but on the low side for middle frequency units and tweeters. The meter is, therefore, not suitable in the design of a loudspeaker enclosure, because then the impedance at a number of different frequencies needs to be known.

Design considerations

The principle of the impedance meter is almost more interesting than its practical construction. Owing to the inductive reactance, measuring impedances with the aid of a bridge circuit is not as simple as it may appear at first sight. The present meter is, therefore, based on a different design philosophy as shown in Fig. 1.

As the block diagram shows, the meter consists of a quadrature sine wave oscillator, a synchronous rectifier, a voltage source, and a null-point detector. The oscillator provides two signals, $\sin \omega t$ and $\cos \omega t$, that have the same frequency, but are 90° ($\pi/2$) out of phase. The $\sin \omega t$ signal is used to control a voltage-driven current source, the output of which flows through the impedance, Z , to be measured.

The potential drop across Z consists of two voltages, U_R and U_X , which are 90° out of phase (U_R is caused by the pure resistive part of the impedance, whereas U_X is due to the inductive reactance, X_L). The basis of the meter is that the two oscillator outputs can be adjusted accurately to give a compensating potential at

the inputs of a differential amplifier that is identical to the composite drop across Z . The output of the differential amplifier is then zero. A synchronous rectifier and a null-point detector facilitate the correct setting of the two potentiometers. When both LEDs are quenched, the value of R and X_L can be read off the scale of the potentiometers once these have been calibrated.

Circuit description

The quadrature oscillator is composed of opamps A_1 and A_2 and generates a signal at a level of about 6.5 V and a frequency of around 1000 Hz. The sine wave voltage appears at A , and the cosine one at B . The voltage-controlled current source is formed by A_3 , T_1 , and T_2 , while R_{12} is the current-determining resistor.

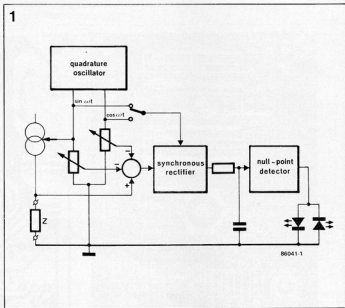
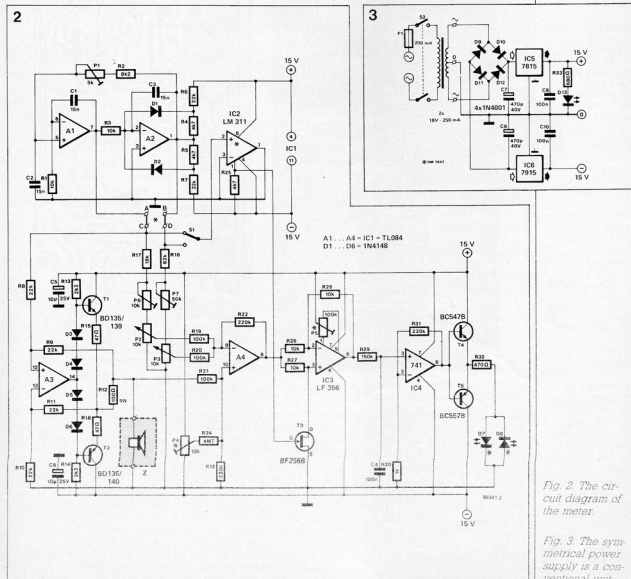

Fig. 1. Block diagram of the meter. The voltage drop across Z is compensated by a composite signal provided by the quadrature oscillator. The values of the resistive and reactive elements can then be read off the scales of the potentiometers.



A1...A4 = IC1 = TL084
D1...D6 = 1N4148

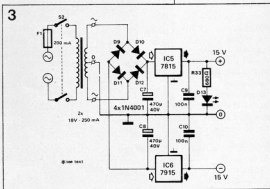
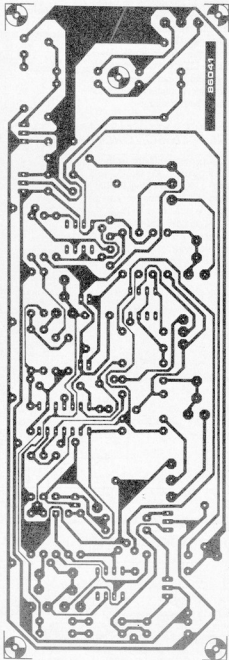
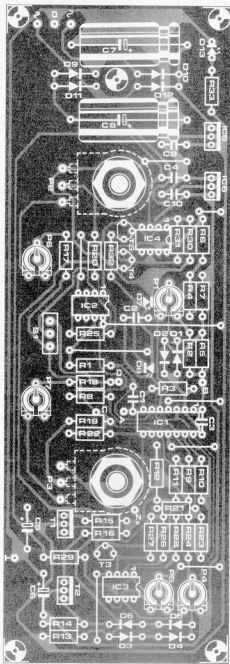

Fig. 2. The circuit diagram of the meter.

Fig. 3. The symmetrical power supply is a conventional unit.

Fig. 4. The printed-circuit board accommodates the entire circuit, including the power supply. Wire links are required between A and C and between B and D.

4



Parts list

Resistors:

R1; R3; R26; R27; R28 = 10 k
 R2 = 8k2
 R4; R5; R25 = 4k7
 Re to R11 incl = 22 k
 R12 = 100 Ω ; 1 W
 R13; R14 = 2k2
 R15; R16 = 47 Ω
 R17 = 18 k
 R18 = 82 k
 R19; R20; R21 = 100 k
 R22; R23; R31 = 220 k
 R24 = 4M7
 R29 = 150 k
 R30 = 1 k
 R32 = 470 Ω
 R33 = 680 Ω
 P1 = 5 k, preset
 P2; P3 = 10 k, linear, wirewound potentiometer
 P4; P5 = 10 k preset
 P6 = 100 k preset
 P7 = 50 k preset

Capacitors:

C1; C2; C3 = 15 n
 C4; C9; C10 = 100 n
 C5; C6 = 10 μ ; 16 V
 C7; C8 = 470 μ ; 40 V

Semiconductors:

T1 = BD135/BD139
 T2 = BD136/BD140
 T3 = BF256B
 T4 = BC547B
 T5 = BC557B
 D1 to D6 incl = 1N4148
 D7; D13 = LED
 D9 to D12 incl = 1N4001
 IC1 = TL084
 IC2 = LM311
 IC3 = 741
 IC5 = 7815
 IC6 = 7915

Miscellaneous:

T1 = mains transformer
 2 x 18V; 250 mA
 S1 = SPST switch
 S2 = double pole mains switch
 F1 = fuse; 200 mA;
 delayed action
 fuse holder to individual requirements
 two wander plugs and sockets (chassis mounting)
 Verobox Type 75-1411D
 PCB 86041
 (see Readers' Services)
 Front panel foil 86041-F
 (see Readers' Services)

The two compensating voltages are taken from the oscillator via potential dividers R17-P1-P2 and R18-P3-P4 and C and D (which are linked to A and B respectively). Since the value of the inductive reactance, X_L , is always much smaller than that of the DC resistance, R, the value of R18 is considerably larger than that of R17. The differential amplifier is formed by opamp A4; potentiometer P4 provides the necessary off-set compensation. The synchronous rectifier is com-

posed of T3 and IC3. The amplification of the latter is +1 or -1, depending upon the state of T3. This transistor is controlled by comparator IC2, the input of which can be connected to the sine or cosine output of the oscillator by S1. The somewhat unusual output configuration of the comparator (output pin 7 to ground and earth pin 1 to -15 V via R26) becomes clearer when it is realized that pins 1 and 7 are connected to the emitter and collector respectively of the output tran-

sistor in the LM311. Series combination R27-C4 smoothes the output voltage of IC3 before this is applied to the null-point detector. The null-point detector consists of a Type 741 opamp, IC4, and two complementary transistors, T4 and T5. As stated before, if during the test P2 and P3 have been set correctly, diodes D7 and D8 will remain quenched. The power supply, which provides symmetrical voltages of ± 15 V, is a fairly simple affair as shown in Fig.3.

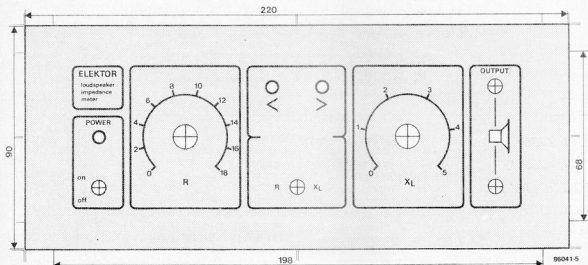

On/off indication is provided by diode D₅.

Construction

The meter is best built on PCB86041 shown in Fig. 4 and housed in a Vero case Type 75-1411D. Note that potentiometers P₂ and P₃ can be mounted direct onto the PCB.

Do not forget wire links A-C and B-D. Connections between the PCB and input and output terminals should be kept short and made in relatively thick wire.

Do not fit C₄ until the meter has been calibrated.

It is advisable to use LEDs of equal brightness in the D₇ and D₈ positions.

Use of the Type 75-1411D Verobox has two advantages: the meter then fits nicely in the Elektor series of measuring instruments, and use may be made of the front panel foil 86041-F available through our Readers' Services—see Fig. 5.

Calibration

Adjust P₁ so that the oscillator just starts, which is conveniently checked with the loudspeaker under test.

Turn P₂ and P₃ fully anticlockwise (wipers to ground), and short-circuit the output terminals. Diodes D₇ and D₈ should now light.

Adjust P₅ until both LEDs are equally bright, and then turn P₄ till they just go out.

Fit capacitor C₄.

Set switch S₁ on the front panel to position R.

Connect a 10-ohm (1 per cent toler-

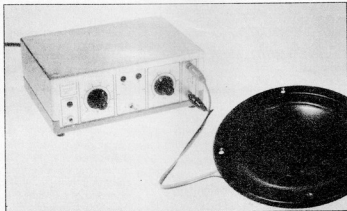

Fig. 5. The front panel of the meter matches those of other instruments in the series.

ance) resistor across the output terminals.

Set P₂ (R) to read 10 and slowly adjust P₆ until both LEDs just go out. Replace wire links A-C and B-D by (temporary) links A-D and B-C. Switch S₁ should remain in position R.

Connect a 3.3-ohm (1 per cent tolerance) resistor across the output terminals.

Set P₃ (X_L) to read 3.3 and slowly adjust P₇ until both LEDs just go out. Remake wire links A-C and B-D.

Using the meter

Connect the loudspeaker under test across the output terminals.

Set S₁ to position R and turn P₂ (R) until the LEDs just go out.

Set S₁ to position X_L and turn P₃ (X_L) until the LEDs just go out.

The inductance of the loudspeaker is calculated from

$$Z = j(R^2 + X_L^2) \quad [\Omega]$$

where R and X_L are the values read from the front panel.

The self-inductance of the voice coil may be calculated from

$$L = X_L / 2\pi \quad [\text{mH}]$$

Experimental extensions

Various extensions may be incorporated, although these have not been tested in our own laboratories. For instance, if wire links A-C and B-D are replaced by a change-over switch that enables A to be linked to D and B to C, it becomes possible to measure capacitive reactances (X_C). Again, if the output of the voltage-controlled current source is made switchable, different measuring ranges become available. And finally, the oscillator could be made to provide a number of switch-selected frequencies. But then, this would not be such a simple instrument any more.

RESEARCH AND THE FUTURE

by C L Boltz

Ring laser compass is amazingly accurate

Able to respond to a turning motion of as little as a thousandth of a degree per hour, the ring laser giro compass has been developed by British Aerospace after a decade of research and development. The instrument is based on a helium-neon laser housed in the base of a triangular block of glass ceramic. The laser emits light in two opposite directions round the triangular path which could, in total, be up to 300 mm long. The two laser beams are projected round the triangle by two plane mirrors polished to such a degree that any irregularities are less than atomic size.

Normally the two beams would arrive at the third corner of the triangle in phase, taking exactly the same time to travel the path. However, if the triangle is rotating rapidly then one beam travels a shorter path than the other and the two arrive out of phase. The beams pass through a transparent flat disc to a photodetector that measures the degree of interference. How much the two beams are out of phase determines the speed of rotation. The data is electronically processed and converted into angular rotation.

The first practical testing of a ring laser gyro was on a Comet aircraft in 1981. Today a high accuracy ring laser gyro is available for ships, and

an order has been received for the Anglo-Italian helicopter, the EH101. The compass is made in several sizes with differing orders of accuracy.

Universities in partnership with industry

An important technological partnership is growing in Britain — that between the universities and industry. Brought about partly by the reduction in government money available through the University Grants Committee this industrial funding is increasing by sponsorship of research, and sometimes by the establishment of industrial companies by the universities themselves. British Petroleum, for instance, is working on plastic membranes to clean oil. Research is based on fundamental work on biological tissues and the company is sponsoring this at the Imperial College of Science and Technology as part of its £1.5 million programme in British universities. Thorn EMI has developed new biochemical sensors for the measurement of blood nutrients. Collaboration is with chemists at Newcastle University. At Loughborough University a method of preventing excavators from overturning has been developed by Loughborough Projects, a company owned by the university.

Salford University has a research company with 60 members and annual sales of £4 million. Newcastle University has a research agreement with an electronics company with an annual turnover of £2 million. Surrey University at Guildford has a club of companies, numbering eight, which each pay it £5000 a year for access to research results and help in solving specific problems. Companies such as British Aerospace, GEC, and ICI are sponsoring research in British universities. Sometimes they fund professorships. It has been estimated that universities are earning about £130 million a year from industry. This is small compared with the £1300 million from public funds, but the university holding companies are growing at about 40% a year.

Night vision for aircraft

GEC Avionics has secured a contract worth £48 million for night vision systems to be installed in Britain's Tornado and Harrier military aircraft. The order also calls for the equipment to be installed in United States Marine Corps AV-8B aircraft. Night vision systems are based on the phenomenon that everything above the absolute zero of temperature emits infra-red light. Special crystals respond to this infra-red with electronic emission. With the

GEC Avionics system, the electronic information is processed in such a way that a picture is displayed on a visual display screen. In addition, the company has used its established head-up system so that the picture is created in front of the pilot's eyes and he sees the view as if he were flying in daylight. The infra-red sensor that transforms radiation into electrons is mounted in the front of the fuselage behind a transparent blister. The output from this sensor is processed by the electronics system to create the signals for the television type cockpit display. The system increases aircraft capability by 200%. A pilot can use his aircraft at night or in smoke or haze. The total night vision was originally conceived at Britain's Royal Aircraft Establishment in its "Night Bird" programme. To this GEC Avionics added its expertise with electronics and head-up circuitry.

Energy from nuclear fusion

Britain, within the European Community, has signed an agreement to collaborate in research into the generation of electricity by nuclear fusion. The most advanced fusion system so far is the toroidal chamber magnet. Known as tokamaks, the largest and most powerful of these is the Joint European Torus (JET) situated near the Harwell

research establishment of the United Kingdom Atomic Energy Authority. The United States of America has the TFTR at Princeton, and in Japan there is the JT-60.

The new European Community collaboration was brought about by the increasing realisation that the fusion of the nuclei of light atoms to release energy, is, in practice, very difficult. The light nuclei are those of hydrogen, deuterium or tritium. Deuterium occurs in vast quantities in the oceans and would cost little to produce.

If fusion could produce more energy that is used to create if the world would have a never ending source of cheap energy. However, experiments have shown that to achieve this the electrified particles must have energy equivalent to a temperature of 100 million °C. So far less than half this has been achieved.

No country can claim anything but comparatively minor achievements. Even so, each discovery is progress.

JET is a major engineering structure, as big as an enormous factory, and estimated to cost £600 million on completion. Getting the high temperature is just one of the major problems. There is also the very difficult problem of containing the electrified particles, or the plasma. This is achieved by the use of three immense, sophisticated magnetic circuits to repel the plasma from the walls of the containing torus — the doughnut shaped hollow vessel.

There are four phases in the experiment. Phase 1 was completed in 1983, and Phase 2 in 1985. Phase 3 is due to be completed in 1988 and Phase 4 in 1989, when full power operation will be reached with deuterium and tritium plasmas.

The neutrons produced during fusion will heat up a blanket of lithium to

raise steam for turbines. However, it will probably be well into the next century before it is known whether a fusion reactor is feasible.

Nuclear fusion is very much a prospect of long term research, but the achievement would be of outstanding importance for the whole world.

ICI's lead in the surface science

ICI has installed new apparatus that, it claims, puts it ahead of its rivals in the field of surface science. This is important in many fields such as metal corrosion and the adhesion of paints and coatings, as well as the continuing study of catalysts.

The new apparatus called laser ionization mass analysis (LIMA) makes it possible for analysis to be made at just below the surface. Other techniques such as that of electron spectroscopy for chemical analysis (ESCA) and secondary ion mass spectroscopy (SIMS) deal only with the immediate surface. Both these systems were introduced by ICI. LIMA is made by Cambridge Mass Spectrometry Ltd, and is the only one in use in British industry. There are two others, one at Cambridge University and one at Loughborough University.

LIMA utilises a high power laser to focus a beam down to a diameter of a micrometre (a thousandth of a millimetre). This vaporises a tiny particle under the surface and the vapour is analysed in a mass spectrometer.

This analysis of surfaces is a modern chemical development. It is now known that catalysts, for example, depend on surface activity, and ICI is a leading maker and user

of catalysts, the basis of much modern chemical engineering.

Chlorine by electrolysis

All water for mass distribution comes from lakes or rivers and contains bacteria and dissolved organic matter as well as solids. The solids are removed by filtration, but the bacteria and dissolved organic matter are not. To tackle these, a powerful oxidising agent such as hypochlorous acid or one of the hypochlorites is needed. This can mean that dangerous chemicals have to be stored. Now, however, Cogen Environmental, has devised an electrochlorinator to make chlorine or hypochlorite on site by electrolysis. This involves the splitting of materials in solution by the passage of an electric current.

In the electrochlorinator, a salt solution, even sea water, is electrolysed, and the salt is dissociated in solution into sodium and chlorine. Although sodium hydroxide and sodium hypochlorite may also be produced the result is a total chlorine production. Cogen says that one unit will produce in batch production 200 grams of chlorine per day. That is about 200 litres of gaseous chlorine, enough to sterilise a vast amount of contaminated water.

The research that resulted in the electrolytic manufacture of chlorine was undertaken in the laboratories of the International Research and Development at Newcastle.

*British Aerospace PLC,
Richmond Road, Kingston
upon Thames, Surrey,
England KT2 5QS.*

*University of Surrey,
Guildford, England GU2
5XH.*

*Imperial College of
Science and Technology,
London SW7 2AZ.*

*University of Newcastle, 6
Kensington Terrace,
Newcastle upon Tyne, Tyne
and Wear, England NE1
7RU.*

*Loughborough University of
Technology,
Loughborough, Leicester-
shire, England LE11 3TU.*

*University of Salford, The
Crescent, Salford, England.*

*GFC Avionics Ltd, Airport
Works, Rochester, Kent,
England ME1 2XX.*

*JET Joint Undertaking,
Abingdon, Oxfordshire,
England OX14 3EA.*

*The Interfacial Science
Laboratory, Mond Division,
ICI, PO Box 13, The Heath,
Runcorn, Cheshire,
England WA7 4GF.*

*Cogen Environmental Ltd,
Sunrise Parkway, Lintford
Wood, Milton Keynes,
Buckinghamshire, England
MK14 6LQ.*

HEADPHONE AMPLIFIER

Anyone with a keen ear for hi-fi sound reproduction should read this article, which details how the Type TEA2025 chip was revisited once more to make a versatile, yet compact and low component count stereo headphone amplifier.

Circuit details

Already incorporated in Elektor's portable mixer (see *Elektor India*, issues of June, July, and October 1986) and briefly discussed in the Circuits Special issue of this magazine (*Elektor India*, August & September, 1986), the Type TEA2025 stereo amplifier chip is the basis of the present design of a headphone amplifier circuit, details of which are shown in Fig. 1.

The amplifier chip is fed from a 12 V supply which ensures ample output power for use with 30 to 600 ohms impedance headphone sets. Total harmonic distortion at maximum output is of the order of 0.1%, although it must be noted that the amplifier then produces a sound pressure level which may be harmful to the ears.

The TEA2025 is driven by a pair of symmetrically fed (± 12 V) operational amplifiers whose output level is monitored by overdrive detection circuit T₁-T₂; the PEAK level LED will light in case the safe driving level for the amplifier chip ICs is exceeded. Provision has been made to switch to monaural amplification by means of S₁.

As to the power supply, note that

most current is drawn from the positive 12 V rail, so that an 1 A regulator Type 7812 has therefore been incorporated, while a 100 mA Type 79L12 can easily handle the negative supply demand of the PEAK indicator circuit and that of driver IC₄. Where this is desirable, potentiometers P_{1a} and P_{1b} may be replaced with presets, while driver stage gain may be defined as required by adapting feedback resistors R₁ and R₃.

Construction and applications

With reference to the track pattern and component overlay shown in Fig. 2, hardly anything can go wrong in constructing this versatile headphone amplifier. Note that regulator IC₁ should be fitted with a homemade, U-shaped bracket to aid in cooling the device. It is also suggested to fit IC₃ with a small DIP-type heat-sink, although the device is not too heavily loaded and should, therefore, remain relatively cool.

Volume setting potentiometer P₂ as well as gain adjustment poten-

tiometer P₁, if fitted, are mounted direct onto the PCB, but conventional wiring with short lengths of screened cable may also be used with front-panel mount potentiometers.

Testing the completed amplifier is readily done by switching it to monaural mode and setting P₁ and P₂ to maximum (cw) and minimum (ccw) respectively. Do not apply an input signal while verifying that the outputs of A₁ and A₂ are at 0 V with respect to ground. Apply 10 V_{pp} input signal (3.6 V_{rms}), e.g. from the secondary of a mains transformer, and see if the driver stages can produce 20 V_{pp}; LED D₅ should just about remain off at this level. Maximum output power of the circuit should be achieved with 800 mV_{pp} applied to the inputs of IC₃; output voltage at the R and L terminals should be about 12 V_{pp} at R_L = ∞ , and 8 V_{pp} at R_L = 15 Ω .

Applications of the present circuit other than a hi-fi stereo headphone amplifier include a general-purpose measuring amplifier, if equipped with a simple faultfinding probe, or a line driver for signal distribution in multi-amplifier PA systems.

(57)

Parts list

Resistors:

R1...R4 = 10 k
R5; R6 = 4k7
R7; R8 = 33 k
R9; R10 = 470 Ω
R11; R12 = 2k2
R13; R14 = 56 k
R15 = 22 k
R16; R17 = 6k8
R18 = 680 Ω
P1 = 47 k logarithmic stereo potentiometer*
P2 = 25 k logarithmic stereo potentiometer*

*PCB-mount type

Capacitors:

C1 = 1000 μ ; 25 V
C2 = 220 μ ; 25 V
C3...C6 = 100 n
C7; C17; C18;
C19 = 100 μ ; 16 V
C8; C9 = 470 n
C10; C11 = 1 μ
bipolar or MKT
C12 = 2 μ ; 16 V
C13; C14 = 220 n
C15; C16 = 22 μ ; 6 V
C20; C21 = 150 n
C22; C23 = 470 μ ; 16 V
note: all electrolytic capacitors are radial types.

Semiconductors:

D1...D4 = 1N4001
D5 = red LED & panel holder
T1; T2 = BC557B
IC1 = 7812
IC2 = 79L12
IC3 = TEA2025 (Thomson CSF)
IC4 = TL072

Miscellaneous:

F1 = 100 mA slow
TR1 = 2 \times 12 V at 250 mA
S1 = SPST switch
PCB Type 86086
Clip-on or slide-on DIL

heat sink for IC₃
Soldering pins as required

1

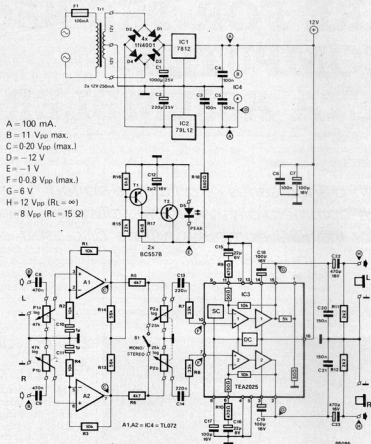

Fig. 1. Not many parts are required to build this high-quality stereo head-telephone amplifier based upon the Type TEA2025 chip. Measuring values relevant to several points in the circuit are shown inset.

2

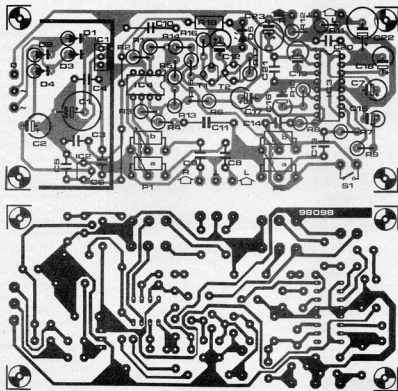

Fig. 2. Showing track pattern and component overlay of the stereo head-telephone amplifier. Note that stereo potentiometers P₁ and P₂ are mounted direct onto the PCB for compact mounting in a small-size cabinet.

SOFTWARE FOR THE BBC COMPUTER: THE META ASSEMBLER

This month a short series of articles is started, in which commercially available software packages for the BBC computer will be discussed in some detail.

The META software package from CRASH BARRIER is a cross-assembler written for the standard BBC micro with disk filing system (DFS), but not intended for machines incorporating the second processor or advanced DFS options.

META comes as two ROMs, one of which, the assembler proper, should be plugged into a high-priority expansion socket; in addition, there are two unprotected system disks, a 40 and a 80-track type. From either one of these disks datafiles (T-files) may be loaded for use as source code translation blocks specific for any one of fifteen types of microprocessor. A single T-file may be used with a number of processors, provided these have identical instruction sets, as, for instance, the Motorola Types 68000 and 68008.

Modular programming by means of macros is fully supported by META, since it allows for source blocks to be disk stored and retrieved, enabling the user to create his own library of frequently called for data tables, initialization procedures, etc., which makes for structured programming. META can handle source

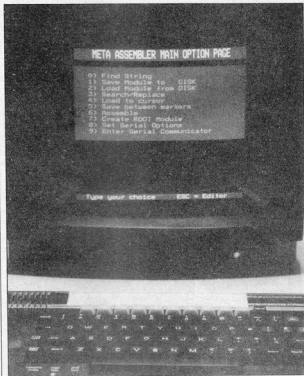

files with a maximum size of one megabyte, which is enough for most practical applications.

META is composed of four functional blocks:

1. Main menu and introduction
2. Text editor
3. Assembler
4. Serial communicator

The latter is a rudimentary

terminal simulation program which enables transferring machine code from the BBC micro to another system (downloading), while it is also possible to read data from the target system and so use the BBC as an emulator system; the hardware required for doing so will be discussed later on in this article.

Editing source text

The META text editor is entered automatically by running the program initially. The editor first arranges for the ROOT file to be fetched from disk, thereby loading specific data for the relevant microprocessor type. CRASH BARRIER have supplied a number of adhesives in anticipation of users creating their own disks to go with different processors, thus encouraging them to gain fast access to the requisite program given a particular assembling task to be run on the BBC micro. In order to aid users in understanding the method of using ROOT and T-files, two example programs can be loaded and run under META, namely the MAZE game (directory S) and a sample monitor program (directory M) which is ready to run on the target system. The META full-screen editor uses computer display mode 7, which means that screen width is 40 characters. Screen is divided into three columns: label field, opcode field and address/data field, while any comment lines

are visible on a second MODE 7 screen which appears after issuing a sideways scroll command. The computer's colour capability is put to good use by META. A slightly annoying shortcoming of the editor is, however, its inability to recognize and load files composed using VIEW.

META's text editor proper is a very flexible program which has a vast number of optional data routing facilities such as object code storage on disk or in resident memory, printing either on screen or using a hard copy device, loading and moving about text blocks, identifying source files with markers, printing after pass 1 or 2, etc.

Assembling object code

The META assembler is capable of supporting several types of microprocessor manufacturers' standards as regards label size, EQU\$ and EQU\$ definition, overall as opposed

to location-specific use of labels, and the use of calculated vectors, to name but a few.

Since META, as opposed to the BBC assembler, is based on disk rather than direct access memory storage and retrieval subroutines, the overall execution time of source assembling is slightly longish.

Labels may have a maximum length of 32 bits and may be stored in direct access as well as in sideways RAM; this also goes for META itself. At the end of an assembler listing, a symbol (label) table may be printed for use as a reference in locating macros and subroutines; in all, the assembler works out to be an easy-to-control program.

Portal

Fully supported by META and connected direct to the computer's user port, PORTAL offers instantaneous access to existing systems' resident memory and thus puts the BBC

micro in control of programs under development or emulation and intended to run using a wide variety of currently available microprocessors. PORTAL is in fact a RAM block, accessible on the basis of multiplexing to both the system to be emulated and the BBC micro loaded with META. In practice this means that PORTAL is simply plugged into the system's EPROM socket; EPROM capacity of up to 16 Kbytes (Type 27128) can be accommodated by PORTAL, which is connected to the relevant EPROM socket by an 28-way flat ribbon cable.

PORTAL makes it possible to load, examine, debug, alter, and send back machine code in a fully operative system, without the need to program a prototype EPROM after every (minor) modification, brought about by the programmer.

The instruction manual to PORTAL states that the in-circuit emulator is readily expandable to hold up to 64 Kbytes of object code; this merely requires two RAM chips to be substi-

tuted with larger capacity types.

Conclusions

META is a powerful cross-assembler offering a vast number of interesting facilities for system development. However before actually being able to exploit all of its features, the user must spend quite a lot of time in getting used to the astounding number of commands and system options as detailed in the manual to the package. It was felt that this manual may well be somewhat too concise for programmers not thoroughly familiar with assembler jargon and (sub)command abbreviations; the text moves at great pace and an occasional reference to earlier explanations might have helped to clear up some of the more difficult procedures.

Quite regrettably, META lacks debugging programs for the target processors, and tracing an object program is therefore only possible with the help of a system monitor which is arranged to send bugs to the BBC micro for examination and correction by means of META and PORTAL, if connected. Should META incorporate such debugging facilities, it would be among the most formidable of cross-assemblers for use on personal micros.

When considering the purchase of an assembler for writing fast machine code with the BBC Micro, that from META, priced at £145 (incl. VAT) exclusive of PORTAL and p&p, is hard to beat. (st)

*Crash Barrier
Freestop
Flitwick
Bedford MK45 1YP
Telephone: (0525) 717448*

0 META ASSEMBLER V3.01 (C) 1986 Andy Green/CRASH BARRIER (0525) 717148
E.ROOT Version: 3.00 Revision: B 24/12/85 Page: 13

Symbol Table:

ACIAA...GBL.....0	ASTOR...GBL.....0	AT.....GBL.....7
BITSEND...GBL...CC2C	BSL1...GBL...CC36	BRINIT...GBL...C1EE
BREAK...GBL...C2F3	CBL...GBL...CC33	CURSOR...GBL...D
CS1ND...GBL...CC3	CBL...GBL...CC12	CGET...GBL...CC3A
CGLP...GBL...CC42	CBLP1...GBL...CC4B	CGLP2...GBL...CC55
CGLP3...GBL...CC52	CRLF...GBL...C128	COMP...GBL...C246
COM0...GBL...C278	COM1...GBL...C27A	COM2...GBL...C284
end...GBL...C1C6	GOTO...GBL...C2E5	HEEP...GBL...CC22
HEX...GBL...C111	HEX1...GBL...C11C	HEX2...GBL...C114
HEXIN...GBL...C12D	HEXIN1...GBL...C133	HEXERR...GBL...C14B
HEXOK...GBL...C153	he1to...GBL...C174	INIT...GBL...CCCC
IND...GBL...B	IR999...GBL...C313	JTABLE...GBL...C294
MSG...GBL...CC72	MSG1...GBL...CC78	MSG2...GBL...CC82
MONINIT...GBL...C1C6	NVAL...GBL...C29E	NEXTON...GBL...C286
NEXTUP...GBL...C205	PCSTOR...GBL...43	PSTOR...GBL...6
RES...GBL...A	REGSEND...GBL...C222	REGREF...GBL...C28B
regt1t...GBL...C1AA	SPSTOR...GBL...5	SPACE...GBL...C117
SPACE2...GBL...C11C	SPACE3...GBL...C122	TEMP...GBL...CCC3
va1char...GBL...C1C1	XSTOR...GBL...1	XT...GBL...8
XXXIT...GBL...C2BF	XXXIT2...GBL...C2D2	YSTOR...GBL...2
YT...GBL...9		

Labels used: 61

Example of an end-of-compilation symbol table printed by META. Neatly arranged hard copy as shown here is invaluable help when developing and debugging machine code by means of an assembler.

723 as a constant current source

Figure 1 shows a simplified internal circuit of the $\mu A 723$, equivalents for which are the LM 723 and TBA 281. It contains a temperature-compensated voltage reference, a differential amplifier, driver and output transistors and a current sense transistor for current limiting purposes. A temperature-compensated reference voltage of 7.15 V \pm 5% is available at pin 4 (metal can version) or pin 6 (DIL package version). Familiarity with this internal circuit will aid in understanding the operation of the 723 as a constant-current source, which is shown in figure 2.

The differential amplifier is connected as a voltage-follower, with the output V_O fed directly back to the inverting input. A potential divider, R2/R3, connected across the reference voltage output, feeds a voltage of about 2.2 V to the non-inverting input. Since the differential amplifier is connected as a voltage follower, 2.2 V appears at output V_O . This causes a constant current

$$I = \frac{2.2}{R_1}$$

to flow through R1. Since this current flows from the positive supply rail into the V_C pin, it must also flow through the external load R_L . This current is constant, irrespective of the value of R_L , within certain limits. The maximum value of R_L is given by:

$$R_L = \frac{U_b - 2.2}{I} \quad (\Omega, V, A).$$

Although the maximum output current capability of the 723 is 150 mA, care must also be taken not to exceed the 800 mW maximum dissipation of the IC. Maximum dissipation occurs when R_L is zero, since almost all the supply voltage is then dropped across the output transistor of the IC. The dissipation is given by:

$$P = (U_b - 2.2) \times I \quad (W, V, A).$$

Rearranging this equation and substituting 0.8 W as the maximum dissipation, the maximum current that can safely be supplied (into a short-circuit) is

The $\mu A 723$ precision voltage regulator IC is well known for its versatility, good line and load regulation, and low temperature coefficient. In addition to its many uses as a voltage regulator, it can also be used as a precision current regulator (constant current source).

$$I_{max} = \frac{0.8}{U_b - 2.2} \quad (A, W, V).$$

With a 10 V supply this is approximately 100 mA, and with the maximum supply (37 V) it will be approximately 23 mA.

The 723 may be provided with a thermal shutdown facility to protect against overheating. This is achieved by using the current limit transistor in the IC as a temperature sensor. At 30°C the base-emitter 'knee' voltage of this transistor is about 0.65 V, but at 120°C it has fallen to about 0.5 V. Resistors R4 and R5 (shown dotted) apply approximately 0.5 V to the base of this transistor (note also the dotted connection to the C_S terminal). This is normally less than the base-emitter knee voltage and is insufficient to turn on the transistor, but at 120°C, when the knee voltage has dropped to 0.5 V, the transistor will start to turn on. This will reduce the base drive to the IC's output stage, decreasing the output current and hence the dissipation.

If a larger output current is required than can be provided by the $\mu A 723$, an external power transistor may be added, as shown in figures 3 and 4. If an NPN transistor is used then it is simply connected as an extension of the emitter-followers in the IC's own output stage: base to V_O , emitter to the inverting input of the differential amplifier. However, if a PNP transistor is used a slight

1

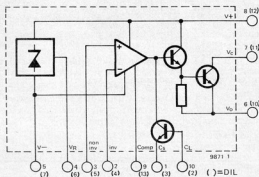

2

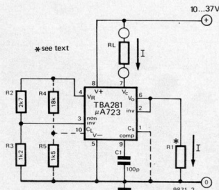

3

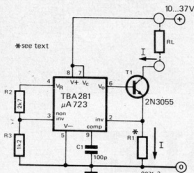

4

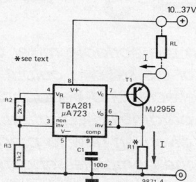

Figure 1. Simplified internal circuit of the 723 IC regulator. Numbers in parentheses are pinout of the DIL package version; others, pinout of the TO-metal can version.

Figure 2. The 723 used as a constant current source.

Figures 3 and 4. If a larger output current is required than can be provided by the 723 alone, an external NPN or PNP power transistor may be added.

rearrangement of the circuit is necessary: V_O and the inverting input are linked, and the base of the transistor is connected to V_C , the collector of the IC's output transistor. The equation previously given for calculating the output current also holds for these two circuits.

The thermal shutdown facility may also be added to these circuits, but it should be emphasised that it will protect only the IC, not the external transistor. As the dissipation in the external transistor may be quite high it is essential to provide it with a substantial heatsink. For example, with a 37 V supply and a current of 1 A, the short-circuit dissipation in the external transistor will be about 35 W!

real load resistors

When measuring and comparing the output powers of audio amplifiers (especially at the high end of the audio spectrum) it is useful to have available a 'real' load resistor, i.e. one which is a pure resistance with no parasitic inductance or capacitance. Carbon film resistors have a low self-inductance, but unfortunately are not commonly available in the high power ratings required for amplifier testing. The highest rating normally available in a carbon film resistor is 2 watts, so a load resistor for testing a 100 W amplifier would need to be made up of 50 such resistors in series/parallel combinations!

Wirewound resistors are available with high power ratings, but unfortunately such resistors are rarely wound so as to minimise self-inductance. A typical high-power wirewound resistor consists of a single layer of resistance wire wound helically on a cylindrical ceramic tube. This type of resistor has quite a high self-inductance, but since the usual applications of high-power wirewound resistors are DC or low-frequency AC this is not important.

1



For use as an amplifier load resistor some means must be found of reducing the inductance of a wirewound resistor. This can be achieved by providing the resistor with a centre tap and connecting it as shown in figure 1. Current flows in opposite directions in each half of the resistor, so the magnetic fields produced in each half (and hence the self-inductances) tend to cancel out. If the original resistor has a value R then the connection shown has a resistance $R/4$ since it consists of two $R/2$ sections in parallel.

Resistors already provided with taps, such as television H.T. dropper resistors, are suitable for this application. Presettable resistors may also be used. These consist of an exposed wire element wound on a ceramic former, and are provided with contact clips that may be fixed anywhere along the length of the element. 1 kW electric fire (heating) elements (which have a resistance of around 60 Ω) may also be used. In order to obtain a load resistor of the desired resistance and wattage rating, several wirewound resistors may be connected in series/parallel combinations in the normal way, provided each one is first connected as shown to minimise its inductance.

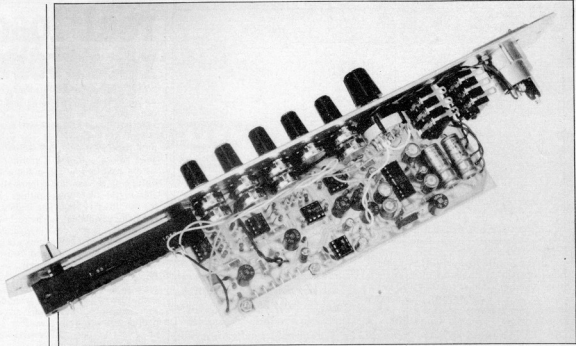

PORTABLE MIXER — 3

by A. Schmeets

This concluding article on the portable mixer details the design and construction of the second output module, comprising the monitor, effects, and headphone amplifiers, as well as the parametric equalizer section. In addition, useful hints are given on how to prepare a light-weight case to hold the complete set of mixer modules.

Output module 2

Fig. 1 shows the circuit diagram of the last module, which incorporates the following sections:

- effects output amplifier
- PFL amplifier
- monitor amplifier with parametric equalizer
- one-chip headphone amplifier

The amplification of the effects output amplifier—A₁—can be set between -6 dB and +14 dB using P₁. Output resistor R₃₀ protects the opamp output transistor in the case of an output short circuit. The PFL summing amplifier—A₃—is

also a single opamp, whose amplification (defined with R₃₇) should equal that of A₂ and the first output module (see last month's issue of *Elektronika* India).

The monitor rail signal is amplified by A₂ in a setup similar to that for the PFL signal. The amplification of A₂, A₃, and the first output module (HP signals) should be made about equal so as to avoid appreciable level differences in the headphone amplifier when switching to one of its three signal sources with S₁. Note that monitor and PFL are mono, while the line signal is stereo (HP_L and HP_R). Attenuation networks R₃₂-P_{3a} and R₃₄-P_{3b} pass one of the above three

signals to a single-chip, stereo headphone amplifier, IC₅, which operates from a regulated 12 V supply (IC₆). The headphone set should have a minimum impedance of 8 ohms, while the total output level may be defined to suit individual requirements by suitable redimensioning of R₂₃ and R₂₄.

Operation of the parametric equalizer (A₄...A₇) is best clarified by studying the curves of Fig. 2, showing that P₂ enables setting the bandfilter centre frequency to any value within the 50 Hz to 10 kHz range, while the setting of P₂ determines the Q (quality) factor, ranging from 2 dB/octave to 14 dB/octave.

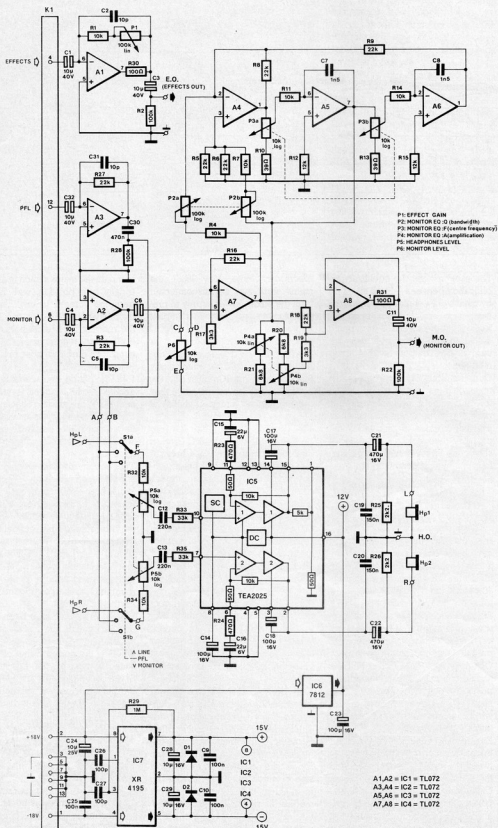

Fig. 1. Circuit diagram of output module number two.

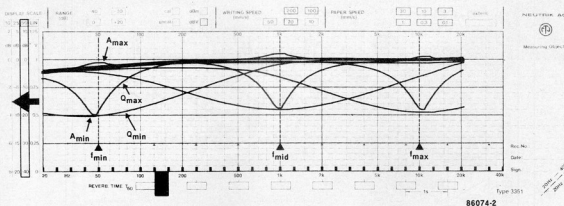

Fig. 2. Frequency curves relevant to the parametric equalizer, incorporated in the monitor output amplifier section.

The user may set the equalizer amplification between -18 dB to $+2$ dB by means of P4. Buffer A5 outputs the frequency-corrected monitor signal, while R31 prevents the IC from being damaged in the case of a short circuit at this output of the mixer module.

Output module 2 is fitted on a ready-made PCB as shown in Fig. 3, and this job should present very few problems if the guidelines given in previous articles in this series are properly observed. Finally, Fig. 4 shows the layout for the front panel foil (FFL) which goes with the present output module.

Mixed matters

In order that the proposed mixer can be carried easily from one site to another, the completed modules are fitted into an aluminium $46 \times 34 \times 14$ cm (width \times depth \times height) photographer's case.

Before detailing the preparation of the case, a number of brief hints will be given regarding the separate modules that constitute the mixer.

Obviously, the slide potentiometers should be mounted in the correct position, that is, the resistance should change from slow to fast when the slide is moved upwards (higher signal level).

Ensure easy movement of the slider knobs by inserting 2 mm spacers between the slider potentiometers and the module front panel.

Cut the spindles of the PCB-mounted potentiometers to a length that enables the knobs to be seated just above the front panel.

All input and output sockets must be isolated with respect to the module panels. As already explained in the first part of this series (see *Elektronika*

India, May 1986), the mains earth may be disconnected from the mixer power supply to prevent trouble with hum in complex equipment setups.

As to the 78L15-79L15 replacement for the Type XR4195 dual regulator chip, it should be pointed out quite clearly that the three-pin ICs must only be used as a very last resort, since they may produce audible clicks at power-on.

The Type U267B VU meter ICs may be damaged when the DC level at their input pins exceeds 5 V. In order that short-duration signal peaks cannot reach this level, zener diodes rated at 4V7 may be connected in parallel with the $1 \mu\text{F}$ capacitors at the IC input terminals. In addition, a 470 ohm resistor is connected in series with the Type IN4148 rectifier in each VU meter circuit; these modifications are easily brought about on the PCB for output module 1.

Most LEDs can be mounted direct onto the PCBs to allow their protruding through the front panels. Where this is not possible, they should be fitted with two-component glue and suitable lengths of wire to connect to the relevant PCB points.

The construction of the power supply is likely to present most difficulties, but the photograph in this article should prove helpful in offering sufficient information to bring the matter to a successful end. Figure 5 shows the outlines of a support screen which serves to improve the mechanical stability of the supply module, as well as to offer an effective shield, useful for the suppression of undesirable stray magnetic fields (transformer hum and mains-induced noise). The screen may also be used to secure PCB and front panel, but due care should be taken

to mount the mains switch in an electrically safe position, well isolated from the screen. In any case, the mains switch should fit snugly into the relevant front panel hole.

The voltage regulators on the mains supply PCB get hot after prolonged use of the mixer and should, therefore, be fitted with suitably cut, angled metal brackets which are secured to the existing heatsinks and the front panel. This modification necessitates the use of insulating washers and bushes with the regulator ICs.

The circuit diagram of the power supply (see *Elektronika India*, May 1986) erroneously shows R_4 and R_5 to have values of 3k6 and 220 Ω respectively, while the parts list indicates the correct values for these resistors. Transformer Tr1 should be a Type 13014, not a Type 11014 as stated, while D_6 is shown with reversed polarity in the circuit diagram; however, it appears correct on the PCB layout.

Finally, R_9 and R_{10} have been shown as 47 k types in the circuit diagram of the stereo module (page 53), whereas the correct value of 22 k is stated in the parts list. Constructors of the above modules are advised to correct the wrong values of the indicated parts in the circuit diagrams.

A home-made flight case

The proposed mixer is contained in an aluminium case, and consists of six MIC-LINE modules, two stereo modules, one output module type 1, one output module type 2 and the power supply module.

Assuming that all modules have

Parts list

Resistors:

- R1, R4, R7, R11, R14;
R32, R34 = 10 k
R2, R22, R28 = 100 k
R3, R5, R6, R8, R9, R16;
R18, R27 = 22 k
R10, R13 = 39 Ω
R12, R15 = 12 k
R17, R19 = 3k3
R20, R21 = 6k8
R23, R24 = 470 Ω
R25, R26 = 2k2
R29 = 1 M
R30, R31 = 100 Ω
R33, R35 = 33 k
P1 = 100 k linear potentiometer*
P2 = 100 k logarithmic potentiometer*
P3, P5 = 10 k logarithmic stereo potentiometer*
P4 = 10 k linear stereo potentiometer*
P6 = 10 k logarithmic slide potentiometer, 58 mm travel

* 4 mm spindle

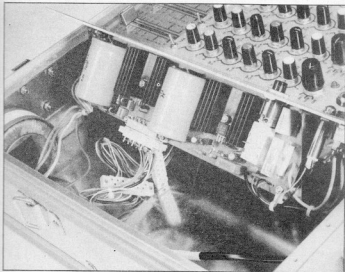

been completed as per the guidelines given in the articles, and that the mixer is equipped with the above module configuration, the number of 13-way sockets to receive the corresponding module plugs amounts to **eleven**.

The 13-way sockets are wired to form a bus structure; the earth connections at pins 3, 5, 7, 9, 11 and 13 are wired from socket to socket with heavy duty, stranded wire of 1.5 mm² cross-sectional area. If the interconnecting wire lengths are about 17 cm, the mobility of each of the modules is ensured; this is of paramount importance for measurements in individual units while the mixer is still functional, since the additional wire length enables the user to readily remove modules from the cabinet for that purpose. However,

Capacitors:

- C₁; C₃; C₄; C₆; C₁₁:
C₂ = 10 μ ; 40 V bipolar electrolytic
- C₂; C₅; C₃₁ = 10 p
- C₇; C₈ = 1n5
- C₉; C₁₀; C₂₅ = 100 n
- C₁₂; C₁₃ = 220 n
- C₁₄; C₁₇; C₁₈:
C₂₃ = 100 μ ; 16 V electrolytic
- C₁₅; C₁₆ = 22 μ ; 6V3
- C₁₉; C₂₀ = 150 n
- C₂₁; C₂₂ = 470 μ ; 16 V electrolytic
- C₂₄ = 10 μ ; 25 V electrolytic
- C₂₆; C₂₇ = 100 p
- C₂₈; C₂₉ = 10 μ ; 16 V electrolytic
- C₃₀ = 470 n

Semiconductors:

- D₁; D₂ = 1N4148
- IC₁; IC₂; IC₃; IC₄ = TL072 (Thomson)
- IC₅ = TEA2025
- IC₆ = 7812
- IC₇ = XR4195
- IC₈ = TL071

Miscellaneous:

- S₁ = 2-pole, 3-way rotary switch
- 6.3 mm stereo jack socket, insulated version
- 2 off 3-way Cannon (XLR) sockets
- K₁ = 13-pole PCB-type connector to DIN41617
- Knobs for potentiometers as required (4 mm spindle)
- Knob for slide potentiometer
- Front panel foil Type 86012-5F*
- PCB Type 86012-5*
- 13-way sockets to DIN41617 as required

* available through our Readers' Services

3

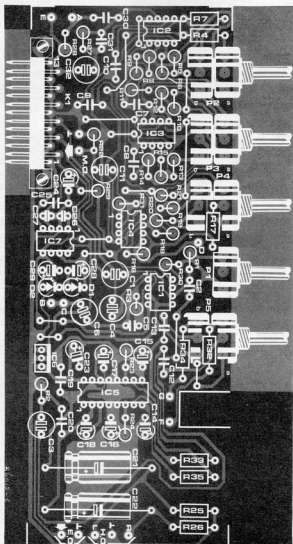
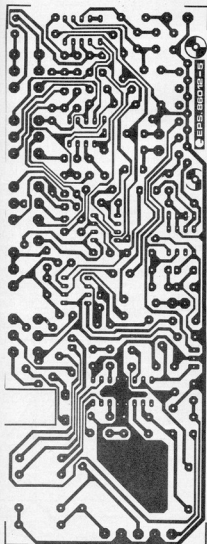

Fig. 3. Component mounting plan for output module number two. The true-scale track layout for this PCB may be found on the centre pages in this issue.

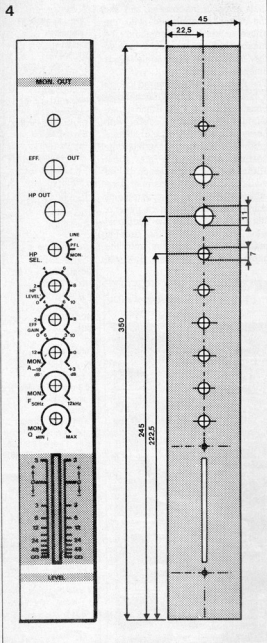
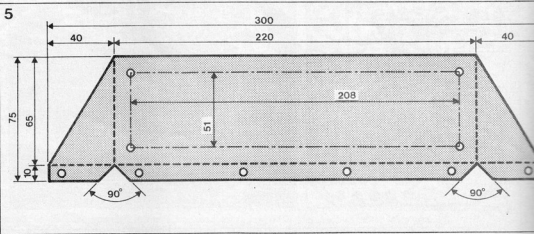

Fig. 4. Front panel foil layout and drilling template.

Fig. 5. Showing the additional screening bracket for the power supply unit.



it should be pointed out that excessive bus wire lengths are to be avoided in view of the increased susceptibility of the modules to externally generated noise. Socket pins 4, 6, 8, 10 and 12 are connected with light duty wire (cross sectional area 0.15 mm^2), and the power supply pins 1 and 2 are "bussed" using 0.75 mm^2 type wire. The mains transformer is mounted in the upper right hand corner of the aluminium case. The wires from the mains socket should be run direct to points 1 and 2 on the supply PCB, while the transformer primary winding is connected to points 3 and 4; the secondary windings are wired to points 5-6 and 7-8. The mains earth isolating switch S_2 is preferably fitted at the rear of the case; neon lamp La_1 is connected direct across the

switch terminals. Point 9 on the PCB is connected to the case ground with a suitable length of wire and a solder tag.

Finally, the photographer's case needs to be tailored in order that it can receive the completed modules; to this end, holes should be drilled in the front panels and the rim inside the case to enable the modules to be secured with self-tapping screws.

Depending on the type of case, its lid may have to be modified on the inside to allow for the projecting parts (knobs, switches) on the front panels; it should, of course, be possible to close the lid!

The photographs included with this article should be studied carefully to enable individual adaptations to a particular case to be made.

AS/GS

COMPUTERS OF TOMORROW

by David Fishlock

Launched in 1983, the United Kingdom's five year Alvey Programme in advanced technology takes its name from John Alvey, the British Telecom executive who led a government inquiry to determine the country's response to the challenge of Japan's national quest for the fifth generation computer. The name caught on, and people soon began to talk of the £350 million funds made available for research and development as "Alvey money". Funds are provided jointly by the British Government (£200 million) and industry (£150 million), and are channelled to the research teams through a specially established executive agency called the Alvey Directorate. In 1981, when Japan disclosed its idea of a national research and development programme, it soon became clear that no one knew what form the fifth generation computer might take. The first four generations were defined as those based on valves (vacuum tubes), transistors, integrated circuits (chips), and very large scale integration (VLSI) or big chips. Would the fifth generation be an optical computer perhaps, or a machine that spoke a human language?

Working through consortia

The Alvey Directorate has no laboratories of its own. From an office in London it co-ordinates a nationwide research and development programme involving British teams drawn from around 60 companies, including foreign owned ones such as Philips and IBM, 46 universities and polytechnics, and five national

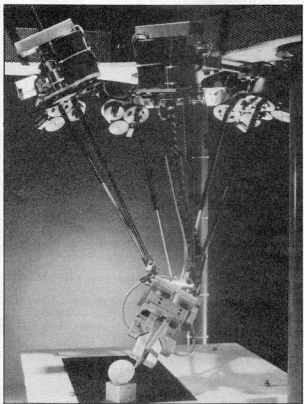

The Gadfly robot from GEC Research Laboratories is part of Britain's Alvey Programme. The robot, seen here fitted with two six-axis force sensors, can be programmed to perform intricate tasks on irregular and delicate surfaces — even, for example, writing on an egg.

laboratories.

It works through consortia or groupings of academic and industrial researchers who have come together to put up a joint proposal for Alvey money. The directorate has backed more than 100 out of 550 such proposals, adding up to a programme with seven broad areas of attack:

1. VLSI: One micrometre geometries or less.
2. Software engineering.
3. Intelligent knowledge based systems (IKBS).
4. Man-machine interfaces (MMI).
5. Systems architecture.
6. Large demonstrators (prototype fifth generation computers).
7. Infrastructure and communications.

The section of the programme attracting the greatest interest is the one involving large demonstrators. These are seen as prototype computers, novel concepts that will give the participating companies a worthwhile commercial lead in five to seven years time. Of seven detailed proposals submitted, the directorate finally chose the four that best matched its overall programme.

These are:

- * A £6.5 million project to develop a new computer system for the British Government's health and social security operations. It is led by ICL.
- * A design to product demonstrator that is, in

effect, a demonstration of a fully automatic factory. It is led by GEC and Lucas-CAV.

- * A speech input word processor and workstation project, expected to form a key part of any fifth generation computing system. It is led by Plessey.
- * A £7.5 million five year project to develop a mobile information system with such capabilities as route guidance and fault location in the electricity supply system. Racal Electronics is the lead firm here.

Community rival

In parallel with the Alvey Programme, the European Community launched the European Strategic Programme of Research in Information Technology (Esprit), of which three British companies — GEC, Plessey and ICL — were among the 42 founding fathers from the European electronics industry. Esprit was conceived as a way of enhancing the strength of European industry. Collaborators have free access to all the technology arising, but are free to choose what they use to design and make their own products. Two new and related European research programmes in advanced enabling technologies are now taking shape, spurred by the success of both Esprit and Alvey. These are Eureka and the recently launched Basic Research in Industrial Technologies for Europe (Brite), which seeks to extend the principles and lessons of Esprit into the more traditional areas of European industry. Britain is playing an important part in helping to shape both projects.

Measuring Techniques

Chapter 2

In the previous chapter of this series, we discussed the different types of meters and multimeters, and the basic types of measurements that can be carried out with them. In this chapter, we shall see how different types of components can be tested with a multimeter.

However it should be noted here, that a multimeter cannot be used for determining how well a component functions, but it can check for defects.

A multimeter can be used for testing components like Electrolytic Capacitors, Transistors, Diodes and quite obviously the Resistors. The multimeter must be kept in the resistance range. In this case, the internal battery of the multimeter serves as the current source. The terminals of the multimeter generally give reversed polarity in the resistance range, that is, the COMMON terminal becomes the plus pole and the other terminal becomes the minus pole.

Resistance measurement is the main function of the resistance range, and details about resistance measurement with the multimeter are always given in the operating manual of the multimeter. Use of this range for testing other components is described below:

Electrolytic Capacitors

A multimeter cannot be used for measuring the capacity of an electrolytic capacitor, but it can be used to check whether the capacitor is defective or not. Electrolytic capacitors are indispensable parts of most electronic circuits. They contain a fluid called electrolyte which can evaporate in course of time and the capacitor is said to have run 'dry'. The capacity to store the charge is thus lost and the two terminals of the capacitor are no longer fully insulated from

each other. The capacitor thus starts conducting a leakage current. For testing the electrolytic capacitors, a high resistance range is to be used (50 K or 100 K). The polarity of the terminals should be carefully maintained because electrolytic capacitors are polarised components. When an electrolytic capacitor is connected to the multimeter for testing (with correct polarity) the needle deflects quickly and then starts falling back slowly. The needle should ideally go back to show infinite resistance. If it doesn't, then it means that the capacitor is leaky. The quick deflection of the needle is caused by the charging current, as the multimeter's battery

charges the capacitor. As the capacitor reaches the fully charged condition, the current reduces and the needle starts falling back. When the capacitor is fully charged, the needle shows infinite resistance. Only in case of capacitors above 500 μF , a small leakage current is permissible and the needle may not reach the infinite resistance mark.

The same measurement can be repeated after about 30 seconds, with same polarity to check if the capacitor can retain the charge. This time the deflection of the needle is very small because the capacitor is already charged and does not draw a substantial charging current from the battery. If the

voltage rating of the capacitor is quite high, it can be touched with the reversed terminals of the multimeter. This time also the needle will deflect quickly and start falling back. Capacitors below 10V rating should not be subjected to this test. Also, in case the internal battery of the multimeter is a high voltage battery, this reverse test should never be carried out.

For testing small value capacitors, the multimeter must be kept in the highest resistance range. In case of capacitors below 100 nF, no visible deflection can be observed.

Diodes

To test the diodes, the multimeter can be kept in 2 K or 20 K range. The diode is connected to the multimeter probes, first in the forward direction and then in the reverse direction. In the forward direction the meter should read a resistance value around 1 K and in the reverse direction it should read a very high or infinite resistance. Please note that when connected in the reverse direction, the probes of the multimeter should not be touched, otherwise the body resistance will come in parallel and a deceptive reading will be shown. The resistance reading given by

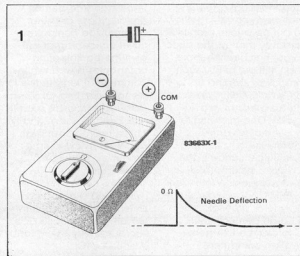
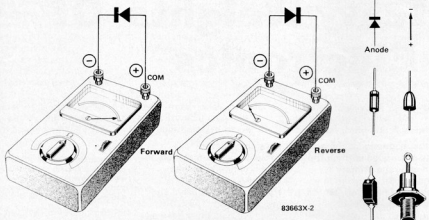

Figure 1 :

If an Electrolytic capacitor is connected to a multimeter, the needle deflects quickly to show the charging current. The charging current drops slowly as shown. When the capacitor gets charged, the needle drops to zero, thus indicating an infinite resistance value.

While connecting the capacitor, polarity must be properly observed. The COMMON terminal of the multimeter is the plus pole in most cases, in the resistance range.

2



the diode in forward direction is the result of the 0.6 V drop across the diode. Diodes in an electronic circuit can also be tested directly on board, provided the circuit is disconnected from its power supply. If the resistance shown in both the directions is same, remove one end of the diode from the PCB and check again. If same readings are given, the diode is defective. Sometimes it may so happen that the diode works properly at low voltage, but behaves as a short circuit if a high voltage is applied in an actual circuit.

Transistors

Transistors are built with two PN junctions, which act as diodes. The Base-Emitter diode or the Base-Collector diode can be checked as discussed previously for individual diodes.

The direction of the diode junctions is different in NPN and PNP transistors as can be seen from figure 3.

When resistance is measured between collector and emitter, it should be an infinitely high value. If a high resistance (about 100 K) is connected between collector and base, the multimeter should show a slight deflection when connected as shown in figure 4. The resistance of 100 K need not be an actual resistor physically soldered between collector and base. It can be replaced by the body resistance by touching the base and collector simultaneously by a wet finger, which causes a small current to flow through the base thus giving rise to a noticeable amount of collector to emitter current, depending upon the gain of the transistor. In case the pin details of a transistor are unknown, this type of measurement can be used to find out the Collector, Base and Emitter pins. Connecting a resistance between base and emitter has no effect on the collector current.

Figure 2: Diodes show infinite resistance in the reverse direction and around 1 K in the forward direction.

Figure 3: The transistor behaves like two diodes connected back to back.

Figure 4: The Emitter-Collector shows an infinitely high resistance in both directions. But when a small current is allowed to flow into the base, the Collector current becomes substantial.

3

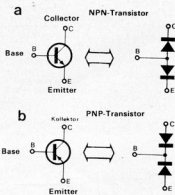

4

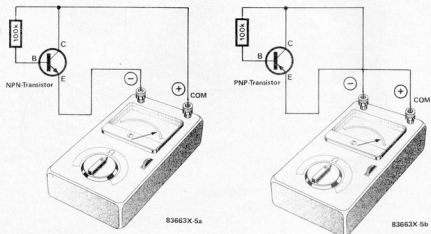

The Heavy Weights Of Electronics

If a mains operated equipment is lifted, it can be immediately noticed, where the transformer is located. This is because it is the heaviest part of an electronic equipment operated directly from the mains power supply.

Transformers are the heavy-weights of electronics, and every designer tries to keep them to the minimum. This heavy structure of metal plates is unavoidable because the magnetic field produced by the primary winding of a transformer must have a suitable medium so that the strength

of the magnetic field is not very poor. Even without the iron core, the primary winding can give rise to a magnetic field in air, but it is too weak. The current required to produce a magnetic field of sufficient strength in the iron core is much less than the current that will be required to produce an equivalent field in air.

In principle, a transformer with an air core is also a transformer, but a very poor one.

Manufacturers of transformer laminations are always engaged in

developing better compositions of materials to obtain optimum results.

Even the shape of the transformer core plays an important part. The magnetic field lines have a property that they try to close in a circular form. Figure 1 shows how the magnetic field lines are curved when going from north pole to south pole in the air gap. Inside the horse-shoe they run from the south pole to the north pole.

The transformer laminations are closely packed to avoid any airgaps, so that minimum energy is lost,

Figure 1 : Magnetic field lines are always closed in a circular path. In case of a horse show magnet, they partially run through the magnet and partially through the air gap.

Figure 2: Magnetic field lines inside a transformer core pass through the central part of the core on which the windings are placed. The outer parts of the core provide two closed paths for the lines. The primary winding converts electrical energy into magnetic field and the secondary winding transforms it back into electrical energy.

Figure 3: Schematic diagram showing how the secondary winding is wound over the primary. There is an insulating layer between the two windings.

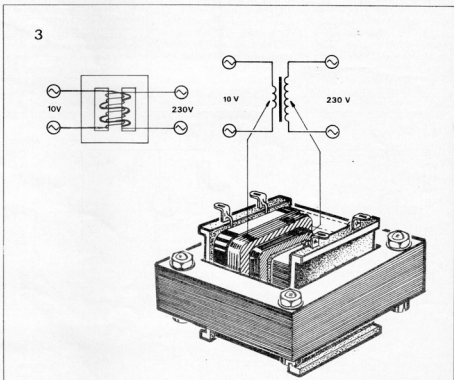
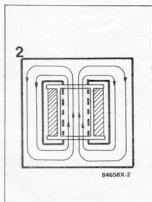
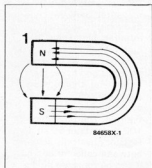

Figure 2 shows the shape of a transformer core, through which the field lines pass. All lines pass through the central part of the core, where the energy is transformed from electricity to magnetism and magnetism to electricity again. The direction of field lines reverses every half cycle.

Transformer cores are generally as shown in figure 2 and 3, but toroidal cores

as shown in figure 4 are found to be more efficient. In this case the windings are distributed throughout the circular shaped block of laminations. Figure 4 shows a comparison between two transformers of same capacity. The small toroidal transformer can manage the same capacity as that of the conventional transformer shown on its side. Toroidal core transformers are more

expensive due to two reasons, due to the material of laminations and because of the complex procedure of winding the coils. As the toroidal core cannot be split up in two pieces as in case of the conventional transformer, the coils have to be wound as shown in figure 5. At first, the wire is wound on the circular toothed ring which runs through the torodial core and then wound on the core

by rotating that ring as well as the core. Insulated copper wire is used for winding the coils of a transformer. The thickness of the wire used depends upon the current which must flow through the winding safely. The length of wire required depends on the number of turns - which in turn depends on the voltages involved.

The magnetic field generated by the primary winding depends on the current flowing through the winding as well as the number of turns in the winding. The secondary voltage induced depends on the number of turns in the secondary winding.

All these relations can be briefly stated by the following formula :

$$\frac{W \text{ prim}}{W \text{ sec}} = \frac{U \text{ prim}}{U \text{ sec}}$$

where W is the number of turns in the winding and U is the voltage.

A concrete example will make this clearer:

A transformer has 2300 turns in its 230V primary winding.

If a secondary voltage of 12V is required, how many turns will be required in the secondary winding ?

$$\frac{2300}{W \text{ sec}} = \frac{230}{W \text{ sec } 12}$$

$$W \text{ sec} = 120$$

Hence the answer is that the secondary winding must have 120 turns.

A transformer data sheet generally gives the ratio of the number of turns to voltage as "Turns per Volt". In the above example, this ratio is 10 turns/volt.

Toroidal transformer windings are wound directly on the core body. However the conventional type of transformer has windings on a plastic former which sometimes may have separators to separate the primary and secondary windings. Small transformers are sometimes cast with plastic compounds to make them safe and reduce hum.

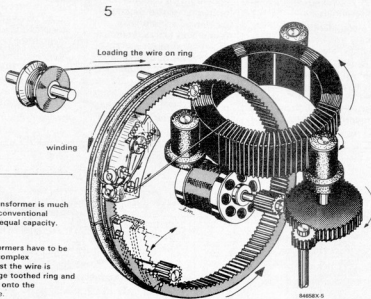
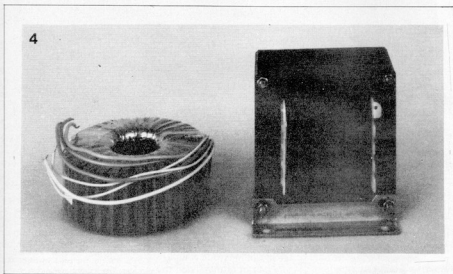

Figure 4: The toroidal transformer is much smaller than a conventional transformer of equal capacity.

Figure 5: Toroidal transformers have to be wound with a complex mechanism. First the wire is wound on a large toothed ring and then transferred onto the transferred core.

Electronic hobbyists frequently come across a typical problem - a transformer which has no markings on it. Many transformer manufacturers find it unnecessary to give the data on the transformer, and this leads to serious difficulties for a hobbyist. What can be done in such a situation?

First of all, let us find out if this is a mains transformer or some other type of transformer. Audio transformers from old valve type radios look very similar to mains transformers, but they are not. There is no reliable way to identify a mains transformer just from its appearance. So a little research must be done, to find out the source from where this transformer came.

The use of an unidentified transformer will finally depend on its ratings, and this can be roughly estimated from its size. As a general rule, a high capacity transformer will always be larger in size. This size increases on one hand due to the thicker and larger lamination block and on the other hand due to the thicker wires used for higher current capacities. Transformer rating are specified at their maximum values and need not be fully loaded at all the times. The load will depend on which equipment we connect at the output. Table 1 provides a rough reference data for frequently used transformers. This table can give you a rough idea about the ratings of the transformer from its size.

The next step is to find out which terminals belong to which winding. A multimeter can be used for this purpose. A multimeter in the lower ranges of Ohms can measure the winding resistance. The higher the resistance, the thinner and longer is the wire and higher is the relevant voltage for the winding. With this measurement, mostly it will be possible to locate the primary 230V winding.

Unknown Transformer Data

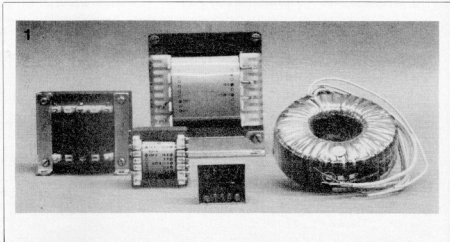

Figure 1 : One can approximately estimate the transformer capacity from its size. The photograph shows 4 conventional M-core transformers, and one toroidal transformer.

Table 1 : Ratings of M-Core type transformers based on dimensions. The last column shows how many turns of winding produce 1 Volt.

If we notice that more than two terminals are connected to the same winding, it must be a winding with several taps on it. For example, it may be a 0—6—9—12V winding with a total of 4 terminals.

Once you identify the primary and secondary windings, almost half the job is over. Do not apply the mains voltage directly to the primary at this stage. It is better to test for the turns ratio using a low AC voltage of the order of a few volts.

About 3 volts from a small bell transformer would be ideal. Connect this voltage to a pair of terminals on the secondary side and then measure the voltage appearing on the other terminals on the secondary as well as primary side. Remember to switch the multimeter into the AC Volts range.

When measuring the induced voltage on the primary side, be careful not to touch the terminals,

Table 1 :

Type	l mm	b mm	VA rating	Turns per Volt.
M42	42	15	4...5	20,6...17,6
M55	55	20	16...20	10,2...8,7
M65	65	27	34...44	6,6...5,6
M74	74	32	62...80	4,7...4,0
M85	85	32	82...107	2,8...2,3
M102a	102	35	143...180	3,0...2,5
M102b	102	52	198...271	2,1...1,7

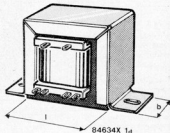

Table 2 :

Current rating in A	Wire Dia inclusive of insulation in mm.
0,011	0,10
0,024	0,138
0,053	0,200
0,094	0,259
0,147	0,316
0,212	0,374
0,289	0,430
0,377	0,487
0,588	0,595
0,849	0,70
1,16	0,81
1,51	0,92
1,91	1,03
2,36	1,13
3,39	1,34
5,30	1,64
6,81	1,96
9,42	2,18
14,73	2,80
21,20	3,35
28,86	3,90
37,71	4,45

Table 3 :

D mm	dmm	VA rating.
63	36	15
70	30	30
80	38	50
90	33	80
90	40	120
110	40	160
110	45	225
110	55	300
140	60	500
140	70	625

Table 2 :

Current carrying capacity of insulated copper wires. The values provided are based on a current density of 3A/mm²

Table 3 :

Dimensions and VA ratings of transformers.

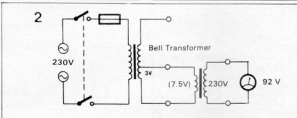
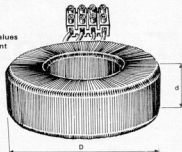

Figure 2 :

For determining the transformer voltage ratios, a small AC voltage is applied to one of the secondary windings of the unidentified transformers, and voltages on other windings are measured. A ratio of these voltages can be calculated.

because it may have directly induced 230V or even more! If the transformer under test is a 3V transformer itself, then the measured voltage on the primary will be 230V. This may be a rare case, and mostly the ratios of voltages measured will require further calculation to get the exact winding details.

Example :

An unidentified transformer has two windings. When 3V AC is connected to the secondary side, the measured voltage on the primary is about 92V.

This gives us the ratio as 92:3, which when modified can be stated as 230:7.5. From this we know that the transformer under test is a 7.5V mains transformer.

A practical situation will not

be so simple, and mostly there will be many taps on the secondary, and sometimes even on the primary side.

If you suspect more than one winding to be the 230V primary, the one with the thickest wire will be the actual primary winding.

If the measured values do not lead to any conclusion, either the transformer is a damaged one or it is not a mains transformer at all.

Once we establish the voltage ratings, we must also estimate the current ratings. This can be done by using the VA (Volt Ampere) ratings given in table 1. Dividing the VA rating by the voltage rating will give the current rating. This is based on the fact that the VA rating of the transformer

holds good both at the primary and secondary

$$P = U \cdot I \text{ (VA)}$$

VA is used in AC instead of Watts because it is not always necessary that the voltage and current will always maintain the same phase relation.

For two transformers with same VA ratings, the lower the secondary voltage, higher is the current rating. For example, a transformer with 10 VA rating and 10V secondary will have 1 Amp current rating on secondary, where as a 10VA transformer with 3V secondary will have 3.3 Amp current rating on the secondary.

Practically, the above rule is not quite accurate because the transformer consumes energy in the core and in

the windings and becomes hot. These losses can be as high as 15%. The primary VA rating must be greater than the secondary VA rating by this amount. The current rating can be found by using the data given in table 1. The thickness of wire can give an accurate indication of the current rating. The diameters of wires given in table 2 are inclusive of the insulating varnish coating. Generally it is enough to know the secondary voltage and current rating of a mains transformer for all practical applications. The methods of identifying a transformer described above are not 100% accurate. However with a little bit of intuition one can decide the suitability of a transformer for a specific application.

The Digilex-PCB is now available!

Price:
Rs. 85.00 + Maharashtra Sales Tax.
Delivery charges extra: Rs. 6.00

Send full amount by DD/MO/PO.

Available from:

precious[®]

ELECTRONICS CORPORATION
Journal Division

11, Shamrao Vithal Marg (Kiln Lane)
 Off Lamington Road, Bombay-400 007.

Transformer Coils In Series & Parallel

We know that the AC voltage has no fixed polarity and that the polarity on each of the terminal changes 100 times per second. But does this mean that the transformer coils also have no polarity?

Not at all! In spite of the fact, that AC has no fixed polarity, the transformer coils cannot be connected in any arbitrary manner. The concept of polarity is however not identical to the DC polarity, in case of transformer windings.

Let us take an example to clarify the concept. Figure 1 shows a transformer with two secondary windings of 15V each connected in series to obtain 30V output. The solid dots shown near the top of the windings play an important role in deciding the interconnection of two windings. If the dots are in the same direction when the two windings are connected, the voltages add up, otherwise the effective voltage is the difference of two voltages. How this happens is further illustrated by figure 2.

Figure 2a shows the primary voltage waveform and the two secondary voltage waveforms. The last waveform shown is the resultant waveform after connecting the two secondary windings in series as shown in figure 1. The individual 15V outputs add up to produce the 30V output. Figure 2b illustrates the result of reversing the 'Polarity' of one of the windings. In this case the effective output voltage becomes zero as the two waveform are opposite of each other. In case of AC we do not use the word 'Polarity' but use the word

'Phase' to describe the direction of the winding. The two 15V waveforms in figure 2b are said to be out of phase with each other. It is not possible to make out from the lugs on the transformer, whether the windings are in phase or not. The correct connection can only be obtained by trial and error, as shown in figure 3a and 3b. The connection which gives the addition of two voltages is the correct one.

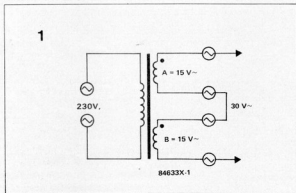
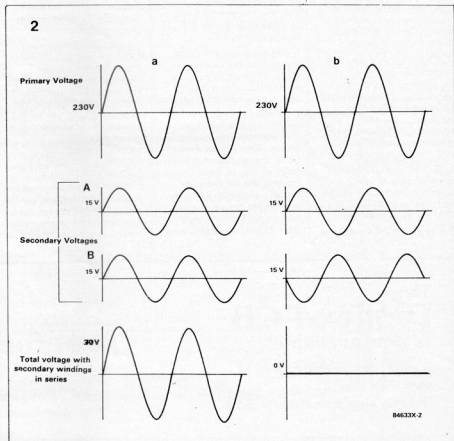

Figure 1 :
Two 15V windings can be connected in series to obtain 30V output. For this reason, the two windings must be connected in correct phase, as indicated by the solid dots on top of the coil symbol.

Figure 2:
a: Secondary windings connected in phase
b: Secondary windings connected out of phase.

As the two half waves are always opposite in direction to each other in case of figure 2b, the resulting voltage is always zero.



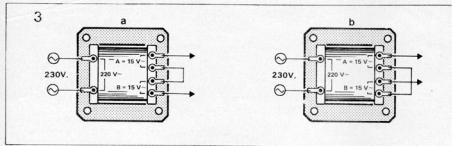

Figure 3:
Two possibilities of connecting the windings in series. Only one can be correct.

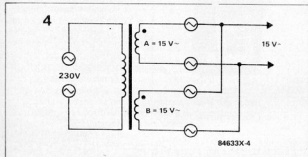

Figure 4:
A parallel connection keeps the output voltage same, but doubles the current capacity.

Figure 5:
Even for a parallel connection, there are two ways of connecting the windings. Only one of them can be correct.

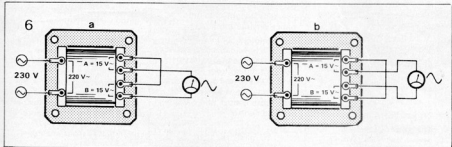
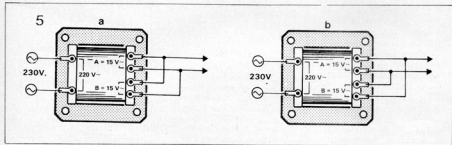

Figure 6:
The windings must be tested before parallel connection, to check if it is safe to make a parallel connection.

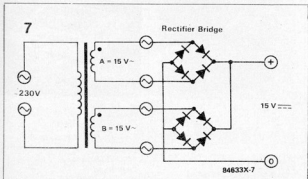

Figure 7:
The rectifier bridges "decouple" both the secondary coils, so that even if the two secondary windings have little voltage difference, there is no compensating current through the windings under no load condition and the transformer does not heat up.

Parallel Connection

We have seen the effect of connecting two secondary windings in series. It is not always necessary that the windings be connected in series. Transformer windings can be connected in parallel also. In case of a series connection, the voltages are added. In case of a parallel connection the voltage remains same, but the current capacity is doubled. Even in case of the parallel connection, the phases must be correct. Figure 4 shows a parallel connection of two 15V secondary windings. The phase of the windings must again be checked by trial and error, using a multimeter in AC V range and connecting the windings as shown in figure 5a and 5b. The windings should be also checked by connecting the terminals as shown in figure 6a and 6b. If the connection as in 6a gives a zero voltage reading, then the connections in figure 5a are the correct parallel connections. For reasons of safety, measurements should also be carried out as in figure 6b; if this gives zero voltage, then the connections in 5b are correct. One important point should be kept in mind before connecting the two secondary windings in parallel. The windings may not be exactly identical and there may be a slight difference between the voltages at these windings. In such a case, a current will flow in these windings even there is no external load connected to the secondary side. This current may heat up the transformer. If the heating is excessive, the transformer must be replaced.

When two parallel windings are to be connected to a rectifier bridge it is advisable to rectify the outputs of both the windings separately and then connect the two rectified outputs in parallel. This avoids the heating of the transformer under no load conditions.

NEW PRODUCTS

SWITCH MODE POWER SUPPLIES

Steadfast Electronics have developed switch mode Power supplies. These SMPS operate on 230V but can withstand a voltage variation from 180V to 264V. The output D.C. voltage remains constant within a close tolerance limit.

On account of their very high efficiencies, low heat dissipation and use of components like ferrite cores, toroidalcores, ICs etc. these SMPS find increasing use as power supplies in TVs Computers, telecommunication equipment etc.



For further details, contact.

STEADFAST

STEADFAST ELECTRONICS CO.
Mill Stores House,
73, Tamarind Street,
BOMBAY-400 023.

EMULATOR FOR 8748

RC Information Technology have introduced a real speed emulator RC-8749 for designers of instruments based on 8748, 8749, 8035 and 8039 single chip microprocessors. Important features of the RC 8749 are - flexible break point and debug system, program may be single stepped or run in full (11 MHz) real time, setting up of any number of break points, auto stop, auto break, triggering of oscilloscope or logic analyser during break points, live display and keyboard while running in any mode, suspension or termination of execution by command etc.



For further information, contact.

RC INFORMATION TECHNOLOGY SYSTEMS PVT. LTD.

1413 Dalamal Towers
Nariman Point, Bombay-400 021
Phone: 244286

INSULATION TESTER

Economy's Digital Insulation Tester has 3 fundamental features:

- 1) It measures insulation properties on two ranges, viz 20 mega ohms and 2000 mega ohms.
- 2) It measures resistance in 5 ranges from 200 ohms with 0.1 ohms resolution, and 2K ohms, 20 K ohms, 200 K ohms and 2 M ohms.
- 3) The instrument is well protected and also measures the line voltage, if the probes are connected to the supply, up to 1000 Volts AC.

Besides, it features sunlight visible LED display, High Sensitivity, High stability, Portability, Single glass epoxy PCB, interlocking switches.



for further details, contact.—

ECONOMY ELECTRONICS
15, Sweet Home, Plot No. 442,
2nd Floor, Pitambar Lane,
off. Tulsi Pipe Road, Mahim,
Bombay 400 016.

DIGITAL DISPLAYS

IRA has come out with 300mm & 150mm seven segment display units, the digidisplay - 300 and Digidisplay-150 where long distance readability is required. Having an environment proof housing of sheet steel, the cabinet is so designed that an array of desired number of digits can be had just by stacking the digits side by side on a panel. The frontdoor is hinged to facilitate

replacement of the fused lamps in the display. A 24V DC drive from an external BCD to 7 segment decoder driver is required to illuminate the segment. Heat sinks are provided to enhance the life of the lamps.

The entire system consisting of A/D converter, parallel BCD output BCD to 7 segment drive, power supply etc. can be supplied by IRA. An additional printer facility is also available.



For more details, please contact.

M/S INSTRUMENT RESEARCH ASSOCIATE PVT. LTD.
P.B. No. 2304,
70/1-2 Magadi Road
Bangalore 560 023.

LAMINATED FRAME D.C. MOTORS

Advani Oerlikon have introduced laminated frame D.C. motors for thyristorised power sources. These motors have excellent commutation properties, can withstand overheating caused by the ripples in thyristorised supplies, better speed control and high power to weight ratio (and hence smaller size)

These motors conforming to IEC-341 have capacities varying from 1.2KW to 300 KW with speeds ranging from 750 RPM to 3000 RPM and are available in 2 series viz. one meant for armature control and the other for field control.

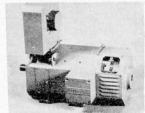

For further details, write quoting Ref. No. P33/A/SH3 to:

M/S ADVANI OERLIKON LTD.
Post Box No. 1546
Bombay-400 001.

We have pleasure in announcing that we will be marketing the Little Dandy range of miniature Soldering Irons manufactured by the American electrical Heater Co. under the Trade name of "AMERICAN BEAUTY"

FEATURES

- LONG LIFE HEATING ELEMENT. Wound on stainless steel spool. No ceramics. No breakage. Lightweight.
- QUICK HEAT. Two minutes from plug-in to working temperature. Fast recovery.
- WIDE RANGE OF WATTAGES to meet your special needs.
- PLUG-TYPE TIPS. Permit fast tip change-over or replacement. Short, for efficient heat transfer.
- MODULAR CONSTRUCTION. Easy maintenance.

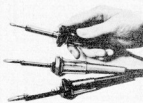

For further details write to:
COMPONENT TECHNIQUE,
8, Orion Apartment
29-A Lallubhai Park Road
Andheri (West)
Bombay-400 058

TEMP. INDICATING CONTROLLER.

PECON has come out with an outdoor type temperature indicating controller having four settings & ON/OFF relay outputs. The unit is wall mounted, works on 220V. AC or DC and has diverse applications. Indication for the maximum temperature attained in any process is available and this maximum temperature is constantly updated till the operation is reset to zero.



For details, contact.

POWER ELECTRONICS & CONTROL
612, Yashkamal
Tilak Road,
Vadodara-390 005

8088 XT MAIN BOARD
 8K EPROM EXPANDABLE
 TO 40K EPROM
 256K RAM ON BOARD
 8 EXPANSION SLOTS
 8088CPU WITH OPTIONAL 8087
 CO-PROCESSOR

Looking for reliable consistent supplies to meet your marketing and production needs? Check us out! Our quality is consistently high, prices are competitive, and deliveries are quick and prompt. We'd like to tell you more about ourselves, so why not contact us today? Big and small orders are welcome!

FLOPPY
 DISK DRIVE CARD
 CONTROL FOUR DS/DD
 DISK DRIVES
 EASY TO INSTALL

COLOR
 GRAPHICS CARD
 USED FOR COLOR,
 MONOCHROME
 R.G.B. AND B/W MONITOR
 WITH VIDEO RCA AND
 R.G.B. OUTPUT

COMPUTER PARTS, COMPONENTS AND C.K.D. AND S.K.D. TO MEET YOUR NEED

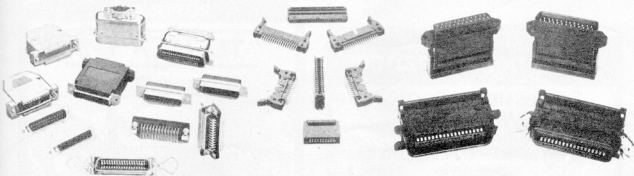

Our Product Range:

- PCB Connectors (2.5mm mini size, 2.54mm, 3.96mm)
- Terminals For Connector Use (M & F)
- Flat Cable (2-64 pins)
- D-Sub Connectors and Hoods (9, 15, 25, 37 pins)
- 57 Series Connectors (M & F)

- IDC Socket/Plug Connectors (16, 20, 26, 34, 40, 50 pins)
- IDC Card Edge Connectors (20, 26, 34, 40, 50 pins)
- 57 Microribbon IDC Connectors (M & F)
- 25 Pin Microribbon IDC Connectors (M & F)
- Cable Assembly

For fully detailed information send your inquiry today!



立偉電子私營有限公司
Device Electronics Pte. Ltd.

Town Office : 101 Kitchener Road #02-04 Jalan Besar Plaza Singapore 0620 Tel: 2986455 (6 Lines)
 Fax: 2926627 Telex: DEVICE RS 33250 Cable: DEVITRONIC

Factory : 605B MacPherson Road #04-12 Citimac Industrial Complex
 Singapore 1336 Tel: 2886455 (6 Lines)

classified ads

Instrument Transformers (very good quality) as per your specification. We can also design a single piece for you. Contact: TEKNO ASSOCIATES K-40 Gandhi Nagar, Gwalior - 474002. Ph. 24806

"DON'T READ THIS ADVERTISEMENT! If you are not interested in saving more than 66% on hundreds of Electronic Books. Write today for FREE Book-list: SRI KRISHNA ASSOCIATES, B/25, Mahesh Co-operative Housing Society, Dattapada Road, BOMBAY - 400 066.

EQUIPMENT SERVICING: Excellent and reliable servicing of industrial equipments, measuring instruments, medical gadgets, computer keyboards, entertainment electronic devices etc. Contact: Anil V Joshi 2A/22 "Geetanjali", New Siddharth Nagar, Goregaon (W) Bombay - 400 062

Wanted computer instructor for computer training institute at Akola. Also want new/used computers, printers, teaching materials. Reply Post Box 84 AKOLA 444 001 (Maharashtra)

"MICROPROCESSOR ENGINEER"
Wanted Bombay based Microprocessor Engineer with atleast two years design experience. Interest in Audio acoustic line an added advantage but not essential. Salary plus perks gross around Rs. 3000/- p.m. Only persons with proven design ability may apply with detailed biodata and projects undertaken or completed. Freshers not wanted. Apply Managing Director, P.O. Box 9122, Bombay - 400 025.

Advertisers Index

ACE COMPONENTS	10.06
APEX	10.66
ATRON	10.08
BELL SYSTEM	10.69
BINATONE	10.04
COMTECH	10.08
CYCLO	10.12
DEWAN RADIOS	10.72
DEVICE	10.61
DISCO	10.69
DYNALOG MICRO SYSTEM	10.76
ELECTRONICA	10.62
ELECTRONIC GMBH	10.12
ELCIAR	10.62
ELECTROKITS	10.72
GRAFICA DISPLAY	10.06
GREAVES	
SEMICONDUCTORS	10.16
IEAP	10.66
INDIAN ENGINEERING	10.70
J M ENTERPRISES	10.71
KIRLOSKAR	10.11
LEADER ELECTRONICS	10.12
LUXCO ELECTRONICS	10.63
MECO INSTRUMENTS	10.73
MOTWANE	10.15
NCS ELECTRONICS	10.64
PIONEER ELECTRONICS	10.10
PRECIOUS ELECTRONICS	10.65
SAINI ELECTRONICS	10.66
SCIENTIFIC	10.06
SEMICRON	10.09
SMJ ELECTRONICS	10.13
SOLDRON	10.69
SONODYNE	10.02
S.S. INDUSTRIES	10.14
SUPERB PRODUCTS	10.14
SWASTICA	10.07
TESTICA	10.62
TEXONIC	10.10
THERMAX	10.08
TRIMURTI	10.72
UNLIMITED	10.64
VASAVI	10.10
VISHA ELECTRONICS	10.75
YABASU	10.70

CORRECTIONS

Battery guard

(Aug/Sept 1986 p. 57)

Diode Dz has been shown with the wrong polarity in the circuit diagram. The positive terminal of C₂ should be connected to the drain of T₁, not the source as shown. In both cases, the relevant PCB and component mounting plan are all right.

PIA for Electron

(Aug/Sept 1986 p. 45)

The designations of pins 10 and 19 of IC₂ have been interchanged: pin 10 should be GND, and pin 19 should be P=Q.

Infra-red light switch

(February 1986 p. 2.33)

The parts list to the project should be modified to read:

P₁ = 10 M preset for horizontal mounting on PCB
C₂; C₄; C₅ = 10 μ; 10 V; tantalum
C₁₀ = 10 n; 100 V

Electronic rotary switch

(Aug/Sept 1986 p. 70)

Pins 1, 8, 9, 10, and 15 of IC₁ and pins 12 and 23 of IC₂ should be connected to ground.

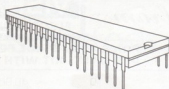

WHICH Microprocessor?

Microprocessors are now being used in a wide range of products, from Mixers and Washing Machines to highly sophisticated Industrial Robots. Have you decided which microprocessor you will be using for your new products? Will it be 8085, Z-80, 8086, 8088, 6802, 6502 or will it be the powerful 32-Bit 68000?

Whichever Microprocessor you select, Dynalog has a suitable Training and Development System for that Chip.

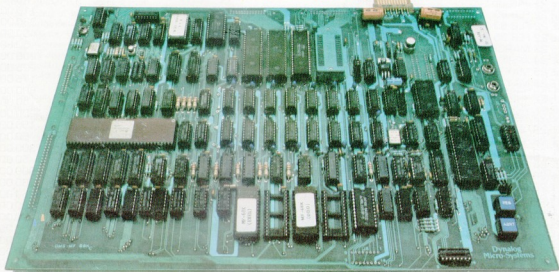

Training And Development Systems Based On : 8085, Z-80, 8086, 8088, 6802, 6502 And 68000.

Dynalog Micro Systems offer you the most comprehensive range of Microprocessor Training and Development Systems. Starting with the Low Cost Systems based on 8085, Z-80 and 8088, the Top of the range covers Single Board Computers based on 6502 and Z-80, and a Full Fledged Single Board Development System based on 68000. The Single Board Computer-Super 80 based on Z-80 has on board interfaces for Centronics Printer, Video Monitor, ASCII Keyboard, RS-232-C Serial Communications and Floppy Disk Drives of both 5 $\frac{1}{4}$ and 8 inch types. It is fully compatible with CP/M Operating System. The standard features of the MICROFRIEND Series Training and Development Systems include Hex Keypad, Seven Segment LED Displays, On board EPROM Programmer, Timer/Counters, Parallel and Serial I/O Ports, STD Bus on edge connector, Powerful Monitor Firmware in EPROM, Detailed Documentation/Operating Manuals etc. Systems like the MICROFRIEND-III also offer facilities for programming in BASIC, FORTH or 8085 ASSEMBLY LANGUAGE with built in interfaces for Video Monitor, ASCII Keyboard and Printer.



Dynalog Micro-Systems

14, Hanuman Terrace, Tara Temple Lane,
Lamington Road, Bombay 400 007

Tel: 362421, 353029 Telex: 011-71801 DYNA IN Gram: ELMADEVICE
Branches and representatives at: Pune, Bangalore, New Delhi, Hyderabad and Chandigarh